

12.3 DOUBLE ROW SELF ALIGNING BALL BEARINGS

Design

Bearings are designed with two rows of balls and round raceway on the outer ring, which enables certain tilting of the inner ring towards the outer ring around the bearing centre without impeding bearing function (fig. 12.3.1). Bearings are made with a cylindrical (a) or tapered (b) bore and are non-detachable. The self-aligning ability, while maintaining functionality, determines the bearing application in cases, where certain misalignment of bores in the bearing hubs or deflection and oscillation of the shaft are expected. Due to the small contact angle and imperfect adherence of the balls to the raceways, they are unsuitable for capturing greater axial forces.

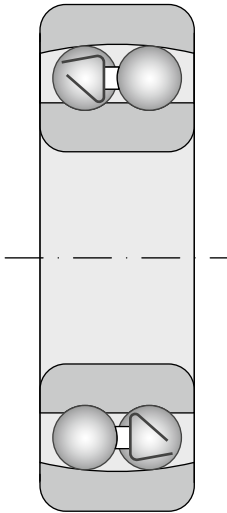

Fig. 12.3.1a

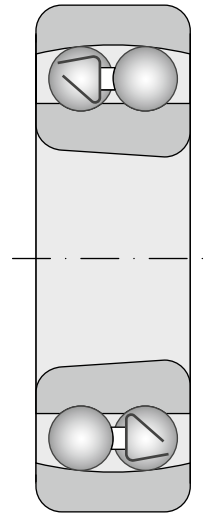

Fig. 12.3.1b

Due to the small adherence of balls on the outer ring spherical surface, self-aligning ball bearings elicit little friction in comparison to other types of bearings and the heat generated is thus also less. The Dunlop product line includes only standard uncovered bearings.

Standard design

Dunlop double row self-aligning ball bearings, manufactured to NEW FORCE standards, are designated as ** in the tables. Standard self-aligning ball bearings are designed with a cylindrical bore. They are also alternatively

designed with a tapered bore (with a 1:12 taper ratio).

Certain series 12 and 13 bearings contain overlapping balls even in the basic non-tilted ring position of the face of both rings. The size of the overlap is specified in the catalogue tables.

Accessories

Adapter sleeves are a basic accessory to self-aligning ball bearings. They serve to fasten bearings with a tapered bore onto the cylindrical shaft. Adapter sleeves are described in the chapter "Bearing accessories." The assignment of adapter sleeves is specified in the catalogue tables.

Main dimensions

The main dimensions of bearings are consistent with standard ISO 15 and are listed for individual bearings in the tables of the publication.

Precision

Bearings are currently produced at a normal degree of precision P0, which is not marked. Bearings for more demanding loadings and higher degree of precision P6 are also supplied.

The dimensional and operational precision tolerances are listed in tables 7.2 to 7.4b and are consistent with standard ISO 492.

Self-alignment ability

Table 12.3.1

Bearing type	Permissible tilt α
d<10mm; series 126; series 13; series 23	$\pm 3^\circ$
series 12; series 22	$\pm 2^\circ 30'$

Self-aligning ball bearings enable, within certain limits, the mutual alignment of rings without negatively affecting the bearing function (fig. 4.9a)

Permissible alignment values of bearing rings, while maintaining functionality, are listed in table 12.3.1.

Internal clearance

Commonly manufactured bearings have a normal internal radial clearance, which is not labelled. Bearings with a reduced clearance C2 or increased radial clearance C3 are supplied for special conditions. The supplier must be consulted for delivery of bearings with C4 and C5 clearance.

Clearance values that conform to standard ISO 5753 are listed in table 7.18. Values apply to bearings prior to installation and without the use of a measuring load.

Table 12.3.2

Bearings with steel sheet or brass cage	Bearings with massive brass or steel cage
d < 10 mm; series 126	-
1200 to 1222	1224 až 1230
2200 to 2222	-
1300 to 1322	1324
2304 to 2320 ¹⁾	2322

¹⁾ Bearing 2305 is manufactured with a massive plastic cage with filler (TNGN)

Cages

Bearings, in their standard design, general have cages as listed in table 12.3.2 (the symbol characterizing the material and cage design is usually not specified).

Note:

TNGN cages can work in bearings for normal operating conditions, i.e. up to +120 °C.

Axial loading capacity

The ability of self aligning ball bearings, installed on adapter sleeves on a shaft without shoulder, to carry axial loads depends on the friction between the sleeve and the shaft. The permissible axial loading capacity can be roughly determined by the relationship

$$F_{ap} = 0.003 \cdot B \cdot d$$

F_{ap} maximum permissible axial loading capacity [kN]

B bearing width [mm]

d bearing bore diameter [mm]

Minimal load

A certain minimal load must act on all single-point contact or line contact bearings to ensure their satisfactory operation. This also applies for self aligning ball bearings, especially when they must operate at high speeds, with high acceleration, or when the direction of the acting load suddenly changes. Under such conditions, the inertial forces of balls, cages, and friction in the lubricant can have a negative effect on the rolling conditions and can cause harmful slippage between the balls and the raceways.

The requisite minimal load for self aligning ball bearings can be estimated using the relationship

$$P_m = 0.01 \cdot C_o$$

P_m minimal equivalent load [kN]

C_o static load capacity [kN]

A higher minimum load may be required when starting under low temperatures or when using a high visco-sity lubricant. The weight of components associated with the bearing together with external forces is often greater than the requisite minimal load. If not, then an auxiliary axial load may act on the bearing, which is elicited e.g. by increased tension of a belt, etc.

Equivalent dynamic radial load of bearing

$$P_r = F_r + Y_1 F_a \quad \text{for } F_a/F_r \leq e \quad [\text{kN}]$$

$$P_r = 0.65 F_r + Y_2 F_a \quad \text{for } F_a/F_r > e \quad [\text{kN}]$$

The values of coefficients e , Y_1 and Y_2 for individual bearings are listed in the tables of the publication.

Equivalent static radial load of bearing

$$P_{or} = F_r + Y_0 F_a \quad [\text{kN}]$$

The values of coefficients Y_0 for individual bearings are listed in the tables of the publication.

Additional markings

Markings of standard bearings and of bearings with a tapered bore are listed in the tables of the publication. Divergence from the standard design is marked by the additional characters provided below:

C2Radial internal clearance less than Normal

C3Radial internal clearance greater than Normal

KTapered bore with 1:12 taper ratio

TNGN.Injected open cage from fibreglass reinforced polyamide 6.6, ball-guided

Installation of bearings with tapered bore

Bearings with a tapered bore have a taper size of 1:12. Bearings with a tapered bore are fastened on a cylindrical shaft using adapter sleeves. Sleeve designations belonging to individual bearings are listed in the tables of the publication.

Self aligning ball bearings with tapered bore are always installed with an overlap on the conical journal or on the adapter or withdrawal sleeve. A decrease in the internal radial bearing clearance or in the axial shift of the internal ring on the conical journal can be used to measure the overlap size. Suitable methods for checking correct installation of self aligning ball bearings with a tapered bore are provided below:

- Measuring the decrease of clearance.
- Measuring the lock nut tightening angle.
- Measuring the axial displacement.

Measuring the decrease of clearance

When installing self aligning ball bearings in standard design with a relatively small Normal radial internal clearance, it generally suffices to check the decrease in clearance during installation by turning and tilting the outer bearing ring. If the bearing is properly installed, then the outer ring can easily be turned; however, you must feel slight resistance when tilting the bearing outer ring. In such a case, the bearing is installed with a correct overlap.

In certain cases, however, the resulting internal clearance for the given application may be too small. Consequently, a bearing with an internal radial clearance of C3 should be used.

Measuring the torque of lock nuts

Measuring the tightening angle of the lock nut presents an easy method of installing self aligning ball bearings with a tapered bore. Recommended tightening angles and lock nut torques are specified in table 12.3.3.

The bearing must be pushed onto the conical journal or sleeve prior to final nut tightening so that it touches the contact surfaces along its entire perimeter (i.e. so it cannot be turned). By tightening the nut by the given angle α , move the bearing on the tapered surface the correct distance. The resulting clearance in the bearing must be checked by turning and tilting the outer bearing ring.

Then unscrew the nut and carefully install the lock washer and re-tighten the nut. Secure the nut by bending the lock washer tab so the tab fits into the slot on the lock nut.

Measuring axial displacement

Installation of bearings with a tapered bore can also be based on measuring the axial displacement of the inner ring on the tapered contact surface. The recommended values of requisite axial displacement "s" are listed in the following table.

Table 12.3.3

Bore diameter	Tightening angle	Axial displacement
d	α	s
mm	degrees	mm
20	80	0,22
25	55	0,22
30	55	0,22
35	70	0,3
40	70	0,3
45	80	0,35
50	80	0,35
55	75	0,4
60	75	0,4
65	80	0,4
70	80	0,4
75	85	0,45
80	85	0,45
85	110	0,6
90	110	0,6
95	110	0,6
100	110	0,6
110	125	0,7
120	125	0,7

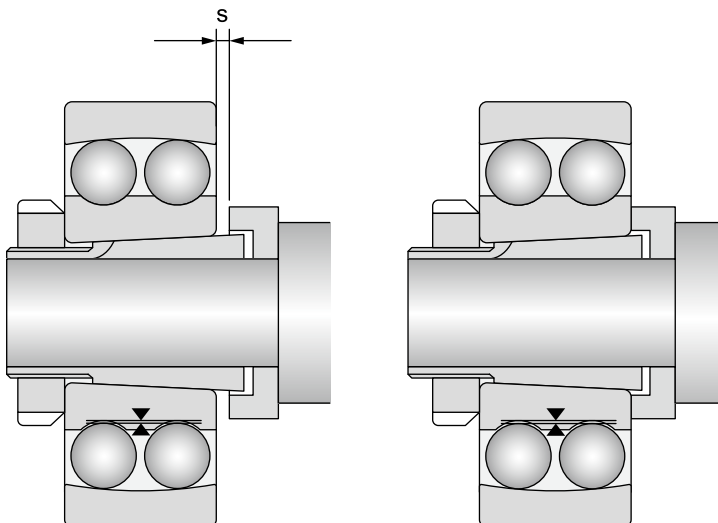
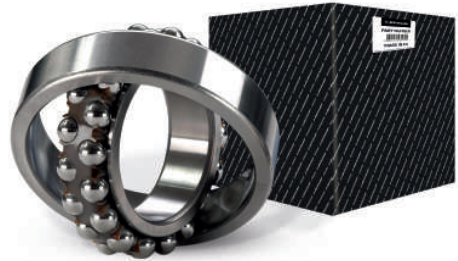
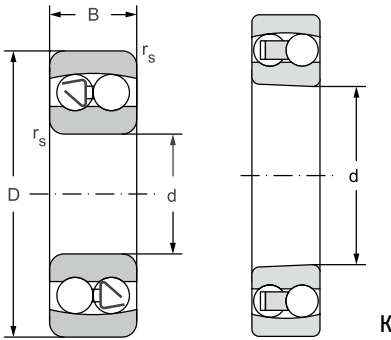

Fig. 12.3.2

Double row self aligning ball bearings d = 10 to 150 mm

d = 10 to 50 mm



12.3.1

Main dimensions					Basic load rating		Fatigue load limit	Limiting speed for lubrication with		Bearing designation	
d	D	B	B ₁ ¹⁾	r _s	dynamic	static				with cylindrical bore	with tapered bore
mm					C _r	C _{or}	P _u	Grease	Oil		
					kN		kN	min ⁻¹			
10	30	14	-	0,6	7,28	1,58	0,07	25 000	30 000	2200	-
12	32	10	-	0,6	5,59	1,26	0,06	24 000	28 000	1201	-
15	35	11	-	0,6	7,41	1,74	0,08	21 000	25 000	1202	-
	35	14	-	0,6	7,61	1,81	0,08	21 000	25 000	2202	-
17	40	12	-	0,6	8,14	2,03	0,09	17 000	20 000	1203**	1203K**
20	47	14	-	1,0	10,20	2,66	0,12	14 000	17 000	1204**	1204K**
25	52	15	-	1,0	12,50	3,35	0,15	12 600	15 000	1205**	1205K**
	52	18	-	1,0	12,90	3,48	0,16	12 600	15 000	2205**	2205K**
	62	17	-	1,1	18,50	5,01	0,23	10 000	13 000	1305**	1305K**
	62	24	-	1,1	25,20	6,56	0,30	10 000	12 000	2305TNGN**	2305KTNGN**
30	62	16	-	1,0	16,70	4,73	0,22	11 000	13 000	1206**	1206K**
	62	20	-	1,0	15,80	4,55	0,21	11 000	13 000	2206**	2206K**
	72	19	-	1,1	22,00	6,31	0,29	9 400	11 000	1306**	1306K**
	72	27	-	1,1	32,30	8,74	0,40	8 400	10 000	2306**	2306K**
35	72	17	-	1,1	16,30	5,11	0,23	9 400	11 000	1207**	1207K**
	72	23	-	1,1	22,40	6,68	0,30	9 400	11 000	2207**	2207K**
	80	31	-	1,5	39,50	11,20	0,51	7 200	8 800	2307	2307K
40	80	18	-	1,1	19,90	6,56	0,30	7 900	9 400	1208**	1208K**
	90	23	-	1,5	29,90	9,81	0,45	7 100	8 400	1308**	1308K**
	90	33	-	1,5	46,10	13,30	0,60	6 700	7 900	2308**	2308K**
45	85	19	-	1,1	22,60	7,36	0,33	7 500	8 900	1209**	1209K**
	85	23	-	1,1	24,00	8,10	0,37	7 500	8 900	2209**	2209K**
	100	25	-	1,5	39,10	12,80	0,58	6 300	7 500	1309**	1309K**
	100	36	-	1,5	55,40	16,50	0,75	6 000	7 100	2309**	2309K**
50	90	20	-	1,1	23,40	8,10	0,37	7 100	8 400	1210**	1210K**
	90	23	-	1,1	24,00	8,41	0,38	7 100	8 400	2210**	2210K**
	110	27	-	2,0	44,60	14,10	0,64	5 600	6 700	1310**	1310K**
	110	40	-	2,0	64,50	19,80	0,90	5 300	6 300	2310	2310K

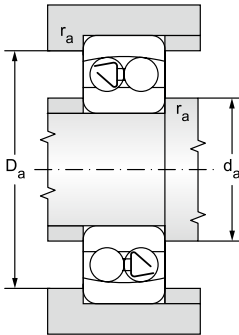

** Bearings in the new standard NEW FORCE
¹⁾ The dimension B1 indicates the bearing width measured over balls if they protrude from the bearing side faces

Abutment and Fillet Dimensions				Weight		Respective adapter sleeve	Coefficients			
d	d _s min	D _s max	r _a max	-	K		e	Y ₁	Y ₂	Y ₀
mm				kg						
10	14	26	0,6	0,0	-	-	0,65	1,0	1,5	1
12	16	18	0,6	0,0	-	-	0,34	1,9	2,9	2,0
15	19	31	0,6	0,0	-	-	0,33	1,9	2,9	2,0
	19	31	0,6	0,1	-	-	0,49	1,3	2,0	1,3
17	21	36	0,6	0,1	0,1	H203	0,31	2,1	3,2	2,2
20	25	42	1,0	0,1	0,1	H204	0,27	2,3	3,6	2,4
25	30	47	1,0	0,1	0,1	H205	0,27	2,3	3,6	2,4
	30	47	1,0	0,2	0,2	H305	0,43	1,5	2,3	1,5
	32	55	1,0	0,3	0,3	H305	0,28	2,3	3,5	2,4
	31	55	1,0	0,3	0,3	H2305	0,47	1,3	2,1	1,4
30	35	57	1,0	0,2	0,2	H206	0,25	2,6	4,0	2,7
	35	57	1,0	0,3	0,3	H306	0,40	1,6	2,5	1,7
	36	65	1,0	0,4	0,4	H306	0,26	2,5	3,8	2,6
	36	65	1,0	0,5	0,5	H2306	0,44	1,4	2,2	1,5
35	42	65	1,0	0,3	0,3	H207	0,23	2,7	4,2	2,9
	42	65	1,0	0,4	0,4	H307	0,37	1,7	2,6	1,8
	44	71	1,5	0,7	0,7	H2307	0,46	1,4	2,1	1,4
40	47	73	1,0	0,4	0,4	H208	0,22	2,9	4,4	3,0
	47	81	1,5	0,7	0,7	H308	0,24	2,6	4,1	2,7
	47	81	1,5	0,9	0,9	H2308	0,43	1,5	2,3	1,5
45	52	78	1,0	0,5	0,5	H209	0,21	3,0	4,6	3,1
	52	78	1,0	0,6	0,5	H309	0,31	2,1	3,2	2,2
	52	91	1,5	1,0	0,9	H309	0,25	2,5	3,9	2,7
	52	91	1,5	1,2	1,2	H2309	0,42	1,5	2,3	1,6
50	57	83	1,0	0,5	0,5	H210	0,20	3,1	4,9	3,3
	57	83	1,0	0,6	0,6	H310	0,29	2,2	3,4	2,3
	60	100	2,0	1,2	1,2	H310	0,24	2,7	4,1	2,8
	61	99	2,0	1,7	1,7	H2310	0,43	1,5	2,3	1,6

Double row self aligning ball bearings

d = 55 to 100 mm

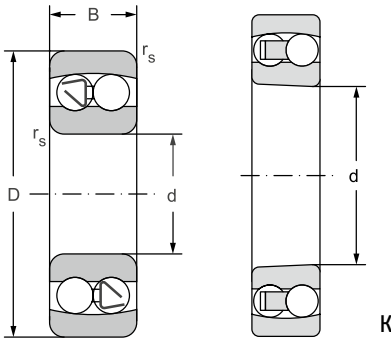

12.3.1

Main dimensions					Basic load rating		Fatigue load limit	Limiting speed for lubrication with		Bearing designation	
d	D	B	B ₁ ¹⁾	r _s	dynamic	static		Grease	Oil	with cylindrical bore	with tapered bore
mm					C _r	C _{or}	P _u				
55	100	21	-	1,5	27,60	10,00	0,45	6 300	7 500	1211**	1211K**
	100	25	-	1,5	27,30	10,00	0,45	6 300	7 500	2211**	2211K**
	120	29	-	2,0	51,50	18,20	0,82	5 300	6 300	1311	1311K
60	110	22	-	1,5	31,00	11,70	0,53	5 600	6 700	1212**	1212K**
	110	28	-	1,5	35,20	12,60	0,57	5 600	6 700	2212**	2212K**
	130	31	-	2,0	58,80	20,70	0,94	4 700	5 600	1312**	1312K**
65	120	23	-	1,5	31,90	12,30	0,56	5 300	6 300	1213**	1213K**
	120	31	-	1,5	44,90	16,50	0,75	5 300	6 300	2213**	2213K**
	140	48	-	2,1	98,90	32,40	1,47	4 000	4 800	2313**	2313K**
70	125	31	-	1,5	45,20	17,10	0,78	5 000	6 000	2214**	2214K**
	150	35	-	2,0	74,50	27,50	1,20	4 200	5 000	1314M	1314KM
	150	51	-	2,1	112,00	37,60	1,63	3 800	4 500	2314**	2314K**
75	130	25	-	1,5	40,10	15,50	0,70	4 700	5 600	1215**	1215K**
	130	31	-	1,5	45,50	17,80	0,80	4 700	5 600	2215**	2215K**
	160	37	-	2,1	81,70	29,90	1,25	3 800	4 500	1315**	1315K**
	160	55	-	2,1	127,00	43,00	1,80	3 500	4 200	2315**	2315K**
80	140	26	-	2,0	41,00	16,80	0,73	4 500	5 300	1216**	1216K**
	140	33	-	2,0	50,50	20,00	0,87	4 500	5 300	2216**	2216K**
85	150	28	-	2,0	50,60	20,30	0,85	4 000	4 700	1217**	1217K**
	180	41	-	3,0	101,00	37,60	1,48	3 300	4 000	1317**	1317K**
	180	60	-	3,0	144,00	51,10	2,02	3 200	3 800	2317**	2317K**
90	160	30	-	2,0	58,60	23,30	0,95	3 800	4 500	1218**	1218K**
	160	40	-	2,0	72,40	28,70	1,17	3 800	4 500	2218**	2218K**
	190	64	-	3,0	158,00	57,30	2,20	3 000	3 500	2318**	2318K**
95	170	32	-	2,1	65,60	27,10	1,07	3 500	4 200	1219**	1219K**
	170	43	-	2,1	85,70	34,10	1,35	3 500	4 200	2219**	2219K**
	200	45	48	3,0	136,00	51,10	1,91	3 000	3 500	1319**	1319K**
	200	67	-	3,0	170,00	64,30	2,41	2 800	3 300	2319**	2319K**

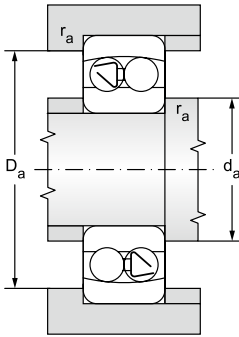

** Bearings in the new standard NEW FORCE

¹⁾ The dimension B_1 indicates the bearing width measured over balls if they protrude from the bearing side faces

Abutment and Fillet Dimensions				Weight		Respective adapter sleeve	Coefficients			
d	d _s min	D _s max	r _a max	-	K		e	Y ₁	Y ₂	Y ₀
mm				kg						
55	62	91	1,5	0,7	0,7	H211	0,20	3,2	5,0	3,4
	62	91	1,5	0,8	0,8	H311	0,28	2,3	3,5	2,4
	66	109	2,0	1,0	1,0	H311	0,23	2,7	4,3	2,9
60	67	101	1,5	0,9	0,9	H212	0,19	3,4	5,3	3,6
	67	101	1,5	1,1	1,1	H312	0,28	2,3	3,5	2,4
	72	118	2,0	2,0	1,9	H312	0,23	2,8	4,3	2,9
65	72	111	1,5	1,2	1,1	H213	0,17	3,7	5,7	3,9
	72	111	1,5	1,5	1,4	H313	0,28	2,2	3,5	2,3
	76	128	2,0	3,3	3,2	H2313	0,38	1,6	2,5	1,7
70	77	116	1,5	1,5	1,5	H314	0,27	2,4	3,7	2,5
	82	138	2,0	3,0	3,0	H314	0,22	2,8	4,4	3,0
	82	138	2,0	3,9	3,8	H2314	0,38	1,7	2,6	1,8
75	82	121	1,5	1,4	1,3	H215	0,18	3,6	5,6	3,8
	82	121	1,5	1,6	1,6	H315	0,25	2,5	3,9	2,6
	86	148	2,0	3,6	3,5	H315	0,22	2,8	4,4	3,0
	86	148	2,0	4,7	4,6	H2315	0,38	1,7	2,6	1,7
80	90	130	2,0	1,7	1,6	H216	0,16	3,9	6,1	4,1
	90	130	2,0	2,0	2,0	H316	0,25	2,5	3,9	2,6
85	95	140	2,0	2,1	2,0	H217	0,17	3,7	5,7	3,9
	98	166	2,5	5,0	4,9	H317	0,22	2,9	4,5	3,0
	98	166	2,5	6,7	6,6	H2317	0,37	1,7	2,7	1,8
90	100	150	2,0	2,5	2,5	H218	0,17	3,8	5,8	3,9
	100	150	2,0	3,2	3,1	H318	0,27	2,4	3,6	2,5
	103	176	2,5	8,0	7,8	H2318	0,38	1,7	2,6	1,8
95	107	158	2,0	3,1	3,1	H219	0,17	3,6	5,7	3,9
	107	158	2,0	4,0	3,9	H319	0,27	2,4	3,6	2,5
	109	186	2,5	6,7	6,6	H319	0,23	2,7	4,3	2,9
	109	186	2,5	9,2	9,0	H2319	0,38	1,7	2,6	1,8

Double row self aligning ball bearings

d = 110 to 150 mm

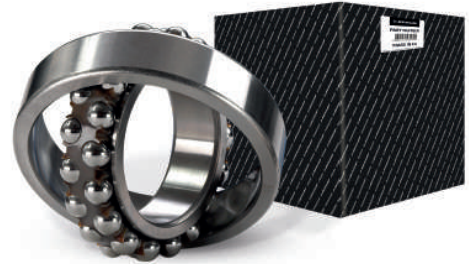
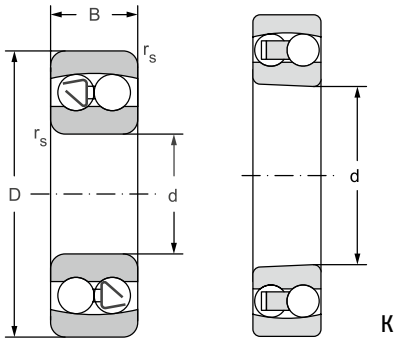

12.3.1

Main dimensions					Basic load rating		Fatigue load limit	Limiting speed for lubrication with		Bearing designation	
d	D	B	B ₁ ¹⁾	r _s	dynamic	static		Grease	Oil	with cylindrical bore	with tapered bore
mm					C _r	C _{or}	P _u				
100	180	34	-	2,1	71,10	29,30	1,13	3 300	4 000	1220**	1220K**
	180	46	-	2,1	96,90	40,60	1,56	3 300	4 000	2220**	2220K**
	215	47	52	3,0	147,00	58,40	2,12	2 800	3 300	1320**	1320K**
	215	73	-	3,0	198,00	77,90	2,82	2 700	3 200	2320**	2320K**
110	200	38	-	2,1	90,50	38,30	1,40	3 000	3 500	1222**	1222K**
	200	53	-	2,1	124,00	52,10	1,90	3 000	3 500	2222**	2222K**
	240	50	55	3,0	168,00	70,80	2,43	2 700	3 200	1322**	1322K**
	240	80	-	3,0	224,00	94,40	3,24	2 500	3 000	2322**	2322K**
120	215	42	45	2,1	119,00	52,10	1,83	2 800	3 300	1224	-
	260	55	62	3,0	196,00	90,90	3,00	2 500	3 000	1324	-
130	230	46	48	3,0	130,00	59,60	2,02	2 700	3 200	1226**	1226K**
140	250	50	54	3,0	164,00	72,20	2,35	2 500	3 000	1228**	1228K**
150	270	54	56	3,0	176,00	85,80	2,69	2 400	2 800	1230**	1230K**

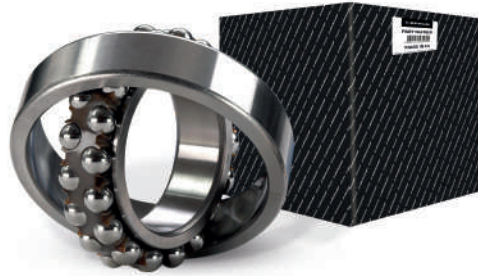
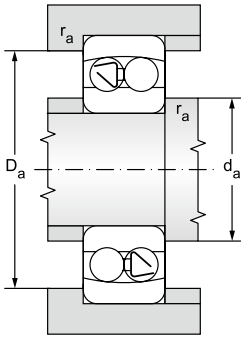

** Bearings in the new standard NEW FORCE

¹⁾ The dimension B₁ indicates the bearing width measured over balls if they protrude from the bearing side faces

Abutment and Fillet Dimensions				Weight		Respective adapter sleeve	Coefficients			
d	d _s min	D _s max	r _s max	-	K		e	Y ₁	Y ₂	Y ₀
mm				kg						
100	112	168	2,0	3,7	3,6	H220	0,17	3,6	5,6	3,8
	112	168	2,0	4,7	4,6	H320	0,27	2,4	3,6	2,5
	113	201	2,5	8,3	8,2	H320	0,24	2,7	4,1	2,8
	113	201	2,5	11,7	11,4	H2320	0,38	1,7	2,6	1,7
110	122	188	2,0	5,2	5,1	H222	0,17	3,6	5,6	3,8
	122	188	2,0	6,8	6,7	H322	0,28	2,3	3,5	2,4
	124	226	2,5	11,8	11,7	H322	0,22	2,8	4,4	3,0
	124	226	2,5	17,3	16,9	H2322	0,37	1,7	2,7	1,8
120	132	203	2,0	6,8	-	-	0,19	3,3	5,1	3,4
	134	246	2,5	15,5	-	-	0,24	2,7	4,1	2,8
130	144	216	2,5	8,3	8,1	-	0,2	3,3	5,0	3,4
	140	236	2,5	10,9	10,6	-	0,20	3,1	4,8	3,3
150	164	256	2,5	13,8	13,5	-	0,2	3,2	5,0	3,4