

12.6 TAPERED ROLLER BEARINGS

Single row tapered roller bearings are detachable. The inner ring with tapered rolls and cage forms one assembly unit: the outer ring a second. The structure with a large number of tapered rolls in a single row allows these bearings to achieve a high radial and axial load capacity. Raceway contact surface areas lie on straight lines, which intersect in the bearing axis. Modifying the contact surfaces of raceways or tapered rolls, resp., limits the formation of edge stress. Axial loading may only occur in one direction and its magnitude depends on the size of the contact angle, which is characterized by the coefficient e . Bearings with a larger contact angle (type 313 and 323B) and thus with a larger coefficient e are more suitable for greater axial forces. A loading with single row tapered roller bearings usually comprises a pair of bearings due to capturing of axial loads in both directions. Bearings are structurally designed to higher utility parameters with the designation A. Bearings are manufactured both in metric and imperial dimensions.

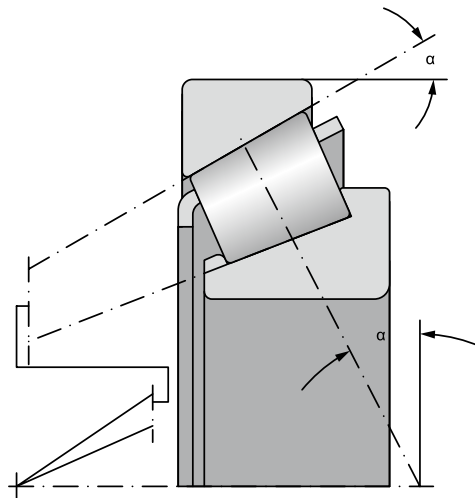

Fig. 12.6.1

Main dimensions

The main dimensions of metric single row tapered roller bearings conform to standard ISO 355. Main dimensions of single row tapered roller bearings in inches meet AFBMA Standard 19 (USA) from 1974.

Labelling

Labelling of standard bearings is specified in the tables of the publication. Divergence from the standard design is marked by the additional characters provided in chapter 7.6 of the catalogue. The current labelling, defined prior to 1977, as well as the new labelling according to ISO 355 is left as a guide in the tables of the publication for customers and manufacturers.

The original labelling is derived from the system described in chapter 7.6 of the catalogue.

In line with dimensional plan ISO 355, the labelling of metric single row tapered roller bearings is expressed using the alphanumeric characters as follows:

- T bearing type
- 2, 3, 4, 5, 7 angle series of bearing **B**,
- C, D, E, F, G diameter series of bearing
- B, C, D, E width series of bearing
- 000 bore diameter in mm

Imperial labelling of bearings corresponds to the common method used by most manufacturers of these bearings. The number before the fraction line designates the inner race with tapered rolls and cage. The number after the fraction line designates the outer bearing race.

Cage

Single row tapered roller bearings have a pressed steel plate cage, which is unmarked. The additional symbol J2 designates a new cage design.

Precision

Bearings are currently manufactured to a normal degree of precision – P0. The marking is not specified. Greater precision bearings P6, P6X, and P5 are supplied for loadings with high precision demands or high operating speeds. Delivery of bearings with precisions P6X and P5 should be negotiated in advance.

Inner clearance

Single row tapered roller bearings are usually installed in pairs, in which the required clearance or pre-load, as necessary, are set during installation. The clearance size or pre-load are determined according to the loading requirements.

Running-in and setting

When installing a pair of tapered roller bearings opposite each other, the bearings must turn to enable correct setting of tapered rolls by functional ball ends in the support flange. Bearings may exhibit somewhat greater friction and thus greater operating temperatures following installation. This will decrease and stabilize after several hours of controlled run-in.

Self-alignment ability

The seating surfaces for these bearings must be aligned with very small deviations, since the permissible self-alignment ability of rings is very small. The self-alignment ability under standard operating conditions

- under small loads ($F_r \leq 0.1C_{or}$)1' to 1.5'
- under large loads ($F_r > 0.1C_{or}$)2' to 4'

Minimal load

Minimal load is necessary to ensure reliable bearing operation, especially in loadings with high speeds, large angular acceleration, and rapid changes in the direction of loading forces. If the minimal load is not secured, then damage may occur to functional surfaces through slippage of rolling elements. Slippage is caused by the inertial mass of tapered rolls and the cage, partially also by friction of the lubricant. Recommended minimal load:

$$F_{r \min} = 0,02C \quad [\text{kN}]$$

C dynamic load capacity [kN]

If the assembly cannot secure this minimal load, then assistance is provided by setting the controlled pre--load in the loading.

Loading of bearings in inch dimensiones

Loading tolerances of these bearings can be selected according to metric bearing tolerances. Due to different tolerances of connecting diameters (deviations in both the bore and surface are positive), however, corrected values from the tables, specified below, must be used. The clearances and overlaps will then correspond to metric values.

Table 12.6.1

Corrected shaft tolerances for bearings in inch dimensiones													
Bore		g6		h6		j5		j6		js6		k5	
over	up to	max	min	max	min	max	min	max	min	max	min	max	min
mm						µm							
10	18	+2	-4	+8	+2	+13	+10	+16	+10	+14	+7	+17	+14
18	30	+3	-7	+10	0	+15	+9	+19	+9	+17	+6	+21	+15
30	50	+3	-12	+12	-3	+18	+8	+23	+8	+20	+5	+25	+15
50	76,2	+5	-16	+15	-6	+21	+6	+27	+6	+25	+3	+30	+15
76,2	80	+5	-4	+15	+6	+21	+18	+27	+18	+25	+15	+30	+27
80	120	+8	-9	+20	+3	+26	+16	+33	+16	+31	+14	+38	+28
120	180	+11	-14	+25	0	+32	+14	+39	+14	+38	+12	+46	+28
180	250	+15	-19	+30	-4	+37	+12	+46	+12	+45	+10	+54	+29
250	304,8	+18	-24	+35	-7	+42	+9	+51	+9	+51	+9	+62	+29
304,8	315	+18	+2	+35	+19	+42	+35	+51	+35	+51	+35	+62	+55
315	400	+22	-3	+40	+15	+47	+33	+58	+33	+58	+33	+69	+55
400	500	+25	-9	+45	+11	+52	+31	+65	+31	+65	+31	+77	+56
500	609,6	+28	-15	+50	+7	-	-	+72	+29	+72	+29	+78	+51
609,6	630	+28	+10	+50	+32	-	-	+72	+54	+72	+54	+78	+76
630	800	+51	+2	+75	+26	-	-	+100	+51	+100	+51	-107	+76
800	914,4	+74	-6	+100	+20	-	-	+128	+48	+128	+48	+136	+76

Table 12.6.2

Corrected shaft tolerances for bearings in inch dimensions											
Bore		k6		m5		m6		n6		p6	
over	up to	max	min	max	min	max	min	max	min	max	min
mm						µm					
10	18	+20	+14	+23	+20	+26	+20	+31	+25	+37	+31
18	30	+25	+15	+27	+21	+31	+21	+38	+28	+45	+35
30	50	+30	+15	+32	+22	+37	+22	+45	+30	+54	+39
50	76,2	+36	+15	+39	+24	+45	+24	+54	+33	+66	+45
76,2	80	+36	+27	+39	+36	+45	+36	+54	+45	+66	+57
80	120	+45	+28	+48	+38	+55	+38	+65	+48	+79	+62
120	180	+53	+28	+58	+40	+65	+40	+77	+52	+93	+68
180	250	+63	+29	+67	+42	+76	+42	+90	+56	+109	+75
250	304,8	+71	+29	+78	+45	+87	+45	+101	+59	+123	+81
304,8	315	+71	+55	+78	+71	+87	+71	+101	+85	+123	+107
315	400	+80	+55	+86	+72	+97	+72	+113	+88	+138	+113
400	500	+90	+56	+95	+74	+108	+74	+125	+91	+153	+119
500	609,6	+94	+51	+104	+77	+120	+77	+138	+95	+172	+129
609,6	630	+94	+76	+104	+102	+120	+102	+138	+120	+172	+154
630	800	+125	+76	+137	+106	+155	+106	+175	+126	+213	+164
800	914,4	+156	+76	+170	+110	+190	+110	+212	+132	+256	+176

Table 12.6.3

Corrected shaft tolerances for bearings in inch dimensions											
Bore		H7		J7		J6		K6		K7	
over	up to	max	min	max	min	max	min	max	min	max	min
mm						µm					
30	50	+36	+25	+25	+14	+21	+19	+14	+12	+18	+7
50	80	+43	+25	+31	+13	+26	+19	+17	+10	+22	+4
80	120	+50	+25	+37	+12	+31	+19	+19	+7	+25	0
120	150	+58	+25	+44	+11	+36	+18	+22	+4	+30	-3
150	180	+65	+25	+51	+11	+43	+18	+29	+4	+37	-3
180	250	+76	+25	+60	+9	+52	+18	+35	+1	+43	-8
250	304,8	+87	+25	+71	+9	+60	+18	+40	-2	+51	-11
304,8	315	+87	+51	+71	+35	+60	+44	+40	+24	+51	+15
315	400	+97	+51	+79	+33	+69	+44	+47	+22	+57	+11
400	500	+108	+51	+88	+31	+78	+44	+53	+19	+63	+6
500	609,6	+120	+51	-	-	-	-	+50	+7	+50	-19
609,6	630	+120	+76	-	-	-	-	+50	+32	+50	+6
630	800	+155	+76	-	-	-	-	+75	+26	+75	-4
800	914,4	+190	+76	-	-	-	-	+100	+20	+100	-14
914,4	1000	+190	+102	-	-	-	-	+100	+46	+100	+12
1000	1219,2	+230	+102	-	-	-	-	+125	+36	+125	-3

Table 12.6.4

Corrected bore tolerances for bearings in inch dimensions									
Bore		M6		M7		N7		P7	
over	up to	max	min	max	min	max	min	max	min
mm		µm							
30	50	+7	+5	+11	0	+3	-8	-6	-17
50	80	+8	+1	+13	-5	+4	-14	-8	-26
80	120	+9	-3	+15	-10	+5	-20	-9	-34
120	150	+10	-8	+18	-15	+6	-27	-10	-43
150	180	+17	-8	+25	-15	+13	+27	-3	-43
180	250	+22	-12	+30	-21	+16	-35	-3	-54
250	304,8	+26	-16	+35	-27	-21	-41	-1	-37
304,8	315	+26	+10	+35	-1	+21	-15	-1	-37
315	400	+30	+5	+40	-6	+24	-22	-1	-47
400	500	+35	+1	+45	-12	+28	-29	0	-57
500	609,6	+24	-19	+24	-45	+6	-63	-28	-97
609,6	630	+24	+6	+24	-20	+6	-38	-28	-72
630	800	+45	-4	+45	-34	+25	-54	-13	-92
800	914,4	+66	-14	+66	-48	+44	-70	0	-114
914,4	1000	+66	+12	+66	-22	+44	-44	0	-88
1000	1219,2	+85	-4	+85	-43	+59	-69	+5	-123

Radial equivalent dynamic load

$$P_r = F_r \quad \text{for } F_a / F_r \leq e \quad [\text{kN}]$$

$$P_r = 0.4F_r + YF_a \quad \text{for } F_a / F_r > e \quad [\text{kN}]$$

The values of coefficients e and Y for individual bearings are listed in the tables of the publication. If the shaft is set in two single row tapered roller bearings, an inner auxiliary force is created during radial loading. The load magnitude of a single bearing is proportional to the load and the contact angle of the second bearing. Auxiliary internal forces in the loading must be factored into the calculation. Table 12.6.5 lists relationships for various bearing arrangements when subject to an external axial force K_a , radial force F_{rA} , F_{rB} acting on bearing A and B. Radial forces act at the intersection of the line with the bearing axis (dimensions "a", "s" are provided in the tables) and are considered to have a positive value, even when their direction differs from that depicted on the figure. The calculated force F_a is substituted into the calculation of the radial equivalent dynamic load.

Radial equivalent static load

$$P_{or} = 0.5F_r + Y_0F_a \quad (P_{or} \geq F_r) \quad [\text{kN}]$$

The values of coefficients Y_0 for individual bearings are listed in the tables of the publication.

Table 12.6.5

Bearing arrangement	Force ratios		Axial loading of bearings	
			Bearing A	Bearing B
Fig. 12.6.2 a 12.6.3	$F_{rA}/Y_A \leq F_{rB}/Y_B$	$K_a \geq 0$	$F_{aB} = 0,5F_{rB}/Y_B$	$F_{aA} = F_{aB} + K_a$
Fig. 12.6.2 a 12.6.3	$F_{rA}/Y_A > F_{rB}/Y_B$	$K_a \geq 0,5 (F_{rA}/Y_A - F_{rB}/Y_B)$	$F_{aA} = F_{aB} + K_a$	$F_{aB} = 0,5F_{rA}/Y_A$
Fig. 12.6.2 a 12.6.3	$F_{rA}/Y_A > F_{rB}/Y_B$	$K_a \geq 0,5 (F_{rB}/Y_B - F_{rA}/Y_A)$	$F_{aA} = 0,5F_{rA}/Y_A$	$F_{aB} = F_{aA} - K_a$
Fig. 12.6.4 a 12.6.5	$F_{rA}/Y_A \geq F_{rB}/Y_B$	$K_a \geq 0$	$F_{aA} = 0,5F_{rA}/Y_A$	$F_{aB} = F_{aA} + K_a$
Fig. 12.6.4 a 12.6.5	$F_{rA}/Y_A < F_{rB}/Y_B$	$K_a \geq 0,5 (F_{rB}/Y_B - F_{rA}/Y_A)$	$F_{aA} = 0,5F_{rA}/Y_A$	$F_{aB} = F_{aA} + K_a$
Fig. 12.6.4 a 12.6.5	$F_{rA}/Y_A < F_{rB}/Y_B$	$K_a < 0,5 (F_{rB}/Y_B - F_{rA}/Y_A)^{1)}$	$F_{aA} = F_{aB} - K_a$	$F_{aB} = 0,5F_{rB}/Y_B$

¹⁾ Applies also for $K_a = 0$

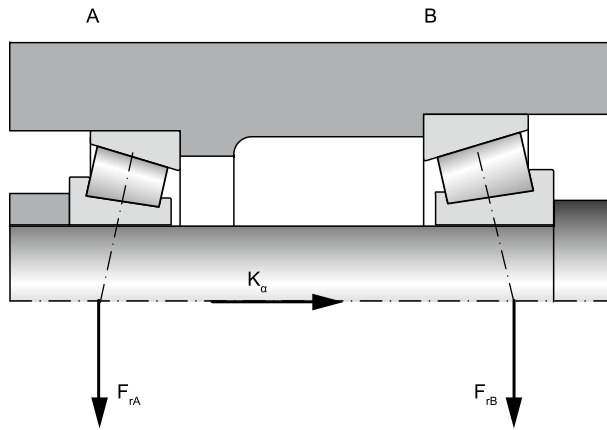

Fig. 12.6.2

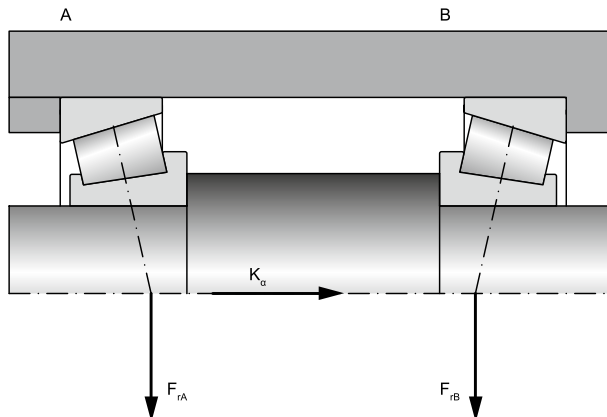

Fig. 12.6.3

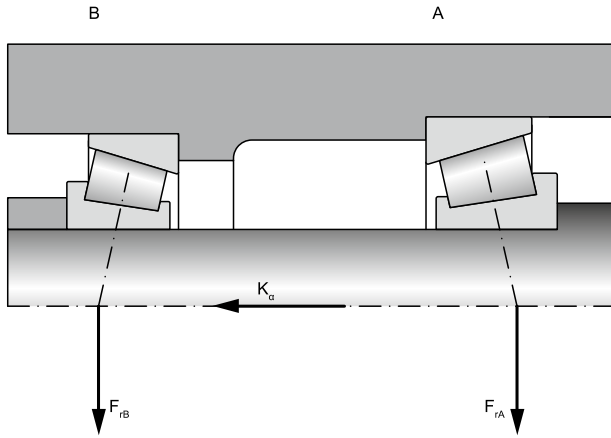

Fig. 12.6.4

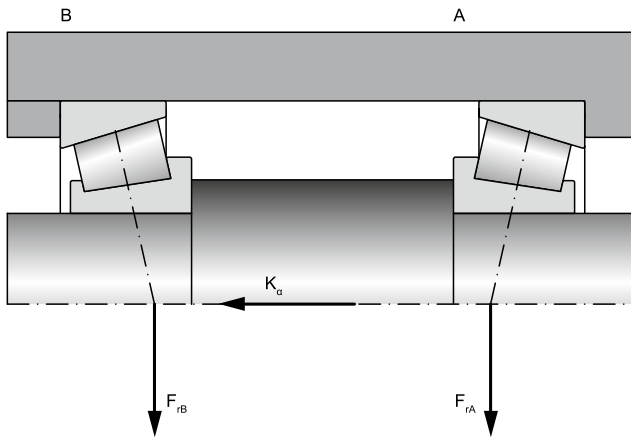
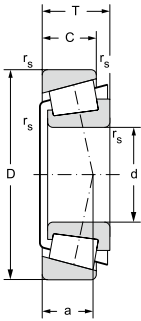

Fig. 12.6.5

Single row tapered roller bearings in metric dimensions d = 15 to 320 mm



d = 15 to 35 mm

12.6.1

Main dimensions									Basic load rating		Fatigue load limit	Limiting speed for lubrication with	
d	D	B	C	T	r _{1s}	r _{2s}	r _{3s}	a	dynamic C _r	static C _{or}	P _u	grease	oil
mm									kN		kN	min ⁻¹	
15	35	11	10	11,75	0,6	0,6	0,3	10	15,2	14,6	1,8	11000	15000
	42	13	11,0	14,25	1,0	1,0	0,3	9,6	22,9	21,6	2,6	10000	14000
17	40	12	11	13,25	1	1	0,3	10	22,2	21,8	2,7	9500	13000
	47	14	12,0	15,25	1,0	1,0	0,3	11	25,1	22,8	2,8	10000	13000
	47	19	16	20,25	1	1	0,3	12	35,4	34,3	3,9	8500	11000
20	42	15	12,0	15,00	0,6	0,6	0,3	10	22,8	29	3,5	9000	13000
	47	14	12,0	15,25	1,0	1,0	0,3	11	25,1	26,1	3,2	8900	12000
	52	15	13,0	16,25	1,5	1,5	0,6	11	30,4	29,9	3,6	8400	11000
	52	21	18,0	22,25	1,5	1,5	0,6	13	43,8	45,5	5,5	8400	11000
25	47	15	11,5	15,00	0,6	0,6	0,3	12	24,2	28,7	3,5	8400	11000
	52	15	13,0	16,25	1,0	1,0	0,3	12	29,9	33,5	4,1	7500	10000
	52	18	16,0	19,25	1,0	1,0	0,3	13,5	36,4	43,2	5,3	7900	11000
	52	22	18,0	22,00	1,0	1,0	0,3	14,1	48,9	58,5	7,1	7900	10000
	62	17	15,0	18,25	1,5	1,5	0,6	13	43,8	42,1	5,1	6900	9200
	62	17	15,0	18,25	1,5	1,5	0,6	13	39,8	38,3	4,7	7100	9400
	62	17	13,0	18,25	1,5	1,5	0,6	20	36,2	39,1	4,8	6700	8900
	62	24	20,0	25,25	1,5	1,5	0,6	15	57,3	60,7	7,4	6700	8900
30	55	17	13,0	17,00	1,0	1,0	0,3	13	35,5	43,8	5,3	7100	9400
	62	16	14,0	17,25	1,0	1,0	0,3	14	39,3	42,8	5,2	6500	8700
	62	16	14,0	17,25	1,0	1,0	0,3	14	40,6	44,7	5,5	6700	8900
	62	20	17,0	21,25	1,0	1,0	0,3	15	50,1	59,6	7,3	6700	8900
	62	25	19,5	25	1	1	0,3	16	68	82	9,9	6000	8000
	72	19	16,0	20,75	1,5	1,5	0,6	15	53,1	53,1	6,5	5600	7500
	72	19	14,0	20,75	1,5	1,5	0,6	23	46,4	50,1	6,1	5300	7100
	72	27	23,0	28,75	1,5	1,5	0,6	20	76,4	85,8	10	5600	7500
32	58	17	13,0	17,00	1,0	1,0	0,3	14	39,8	48,2	5,9	7100	9400
35	62	18	14,0	18,00	1,0	1,0	0,3	15	43	53,1	6,5	6300	8400
	72	17	15,0	18,25	1,5	1,5	0,6	15	46,4	51,1	6,2	5300	7100
	72	23	19,0	24,25	1,5	1,5	0,6	17	64,3	76,4	9,3	5300	7100
	72	28	22	28	1,5	1,5	0,6	18	83	102	12	5300	7100
	80	21	18,0	22,75	2,0	1,5	0,6	16	65,6	69,4	8,5	5000	6700
	80	21	15,0	22,75	2,0	1,5	0,6	26	57,3	63,1	7,7	4700	6300
	80	31	25,0	32,75	2,0	1,5	0,6	20	94,4	110	13	4700	6300

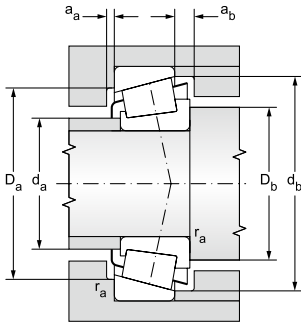

Bearing designation		Abutment and fillet dimensions									Weight	Factors		
ČSN	ISO	d	d _a	d _b	D _a	D _b	D _b	a _a	a _b	r _a	~	e	Y	Y ₀
			max	min	min	max	min	min	min	max				
mm														
											kg			
30202		15	21	21	29	30	32	2	2	0,6	0,06	0,24	2,53	1,39
30302A	T2FB015		22	21	35,0	36	38,0	2	3,0	1,0	0,094	0,29	2,10	1,1
30203	T2DB017	17	23	23	34	34	37	2	2	1	0,08	0,34	1,74	0,96
30303AJ2	T2FB017		25	23	39,0	41	42,0	2	3,0	1,0	0,14	0,29	2,10	1,2
32303	T2FD017		24	23	39	41	43	3	4	1	0,18	0,18	3,26	1,79
32004AX	T3CC020	20	25	25	36,0	37	39,0	3	3,0	0,6	0,1	0,37	1,60	0,9
30204A	T2DB020		26	26	39,0	41	43,0	2	3,0	1,0	0,14	0,35	1,70	1,0
30304A	T2FB020		27	27	43,0	45	47,0	2	3,0	1,0	0,18	0,30	2,00	1,1
32304A	T2FD020		27	27	43,0	45	47,0	2	4,0	1,0	0,27	0,30	2,00	1,1
32005AX	T4CC025	25	30	31	40,5	42	44,0	3	3,5	0,6	0,12	0,43	1,40	0,8
30205A	T3CC025		31	31	43,0	46	48,0	2	3,0	1,0	0,17	0,37	1,60	0,9
32205F			31	31	43,0	46	48,0	2	3,0	1,0	0,2	0,36	1,03	0,8
33205F			30	31	43,0	46	49,0	4	4,0	1,0	0,23	0,35	1,71	0,9
30305A	T2FB025		33	32	53,0	55	57,0	2	3,0	1,0	0,29	0,30	2,00	1,1
30305AJ2	T2FB025		33	32	53,0	55	57,0	2	3,0	1,0	0,27	0,30	2,00	1,1
31305A	T7FB025		33	32	46,0	55	59,0	2	5,0	1,0	0,27	0,83	0,70	0,4
32305A	T2FD025		33	32	53,0	55	57,0	2	5,0	1,0	0,4	0,30	2,00	1,1
32006AX	T4CC030	30	35	36	47,5	49	52,0	3	4,0	1,0	0,18	0,43	1,40	0,8
30206A	T3DB030		37	36	52,0	56	57,0	2	3,0	1,0	0,25	0,37	1,60	0,9
30206AJ2	T3DB030		37	36	52,0	56	57,0	2	3,0	1,0	0,25	0,37	1,60	0,9
32206A	T3DC030		37	36	52,0	56	58,5	2	4,0	1,0	0,32	0,37	1,60	0,9
33206	T2DE030		36	36	53	56	59	5	5,5	0,5	0,35	0,24	2,53	1,39
30306A	T2FB030		38	37	61,0	65	66,0	2	4,5	1,0	0,42	0,32	1,90	1,1
31306AJ2	T7FB030		39	37	55,0	65	68,0	2	6,5	1,0	0,39	0,83	0,70	0,4
32306A	T2FD030		38	37	61,0	65	66,0	2	5,5	1,0	0,63	0,32	1,90	1,1
320/32AX	T4CC032	32	38	38	50,0	52	55,0	3	4,0	1,0	0,2	0,45	1,30	0,7
32007AX	T4CC035	35	40	41	54,0	56	59,0	4	4,0	1,0	0,24	0,45	1,30	0,7
30207A	T3DB035		43	42	61,0	65	67,0	3	3,0	1,0	0,36	0,37	1,60	0,9
32207A	T3DC035		43	42	61,0	65	68,5	3	5,0	1,0	0,48	0,37	1,60	0,9
33207	T2DE035		42	42	61	63	68	5	6	1	0,59	0,37	1,62	0,89
30307A	T2FB035		43	44	68,0	71	74,0	3	4,5	1,5	0,55	0,32	1,90	1,1
31307AJ2	T7FB035		43	44	61,0	71	76,0	3	7,5	1,5	0,52	0,83	0,70	0,4
32307A	T2FE035		43	44	68,0	71	74,0	3	7,5	1,5	0,83	0,32	1,90	1,1

Single row tapered roller bearings in metric dimensions

d = 40 to 50 mm

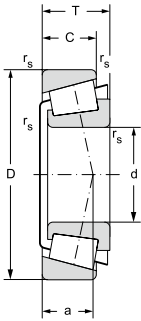

12.6.1

Main dimensions									Basic load rating		Fatigue load limit	Limiting speed for lubrication with	
d	D	B	C	T	r _{1s}	r _{2s}	r _{3s}	a	dynamic C _r	static C _{or}	P _u	grease	oil
mm									kN		kN	min ⁻¹	
40	68	19	14,5	19,00	1,0	1,0	0,3	15	48,2	64,3	7,8	5300	7100
	75	26	20,5	26	1,5	1,5	0,6	18	82	107	13	4800	6700
	80	18	16,0	19,75	1,5	1,5	0,6	17	55,2	60,7	7,4	4700	6300
	80	23	19,0	24,75	1,5	1,5	0,6	18	70,8	85,5	10	4700	6300
	80	32	25	32	1,5	1,5	0,6	21	114	142	17	4800	6300
	90	23	20,0	25,25	2,0	1,5	0,6	18	84,3	93,2	11	4500	6000
	90	23	20,0	25,25	2,0	1,5	0,6	19	82,5	94,4	12	4500	6000
	90	23	17,0	25,25	2,0	1,5	0,6	29	76,4	85,8	10	4000	5300
	90	33	27,0	35,25	2,0	1,5	0,6	22	114	141	17	4200	5600
	90	33	27,0	35,25	2,0	1,5	0,6	27	104,2	136,6	17	4100	5400
	90	33	27,0	35,25	2,0	1,5	0,6	27	104	144	18	4200	5600
45	75	20	15,5	20,00	1,0	1,0	0,3	17	57,3	79,4	9,7	4700	6300
	75	24	19	24	1	1	0,6	16	76	106	13	4800	6300
	80	26	20,5	26	1,5	1,5	0,6	19	89	122	15	4500	6000
	85	19	16,0	20,75	1,5	1,5	0,6	18	61,9	70,8	8,6	4500	6000
	85	23	19,0	24,75	1,5	1,5	0,6	20	73,6	90,9	11	4500	6000
	85	32	25	32	1,5	1,5	0,6	22	118	153	19	4300	6000
	100	25	22,0	27,25	2,0	1,5	0,6	21	107	118	14	4000	5300
	100	25	22,0	27,25	2,0	1,5	0,6	21	104	117	14	4000	5300
	100	25	18,0	27,25	2,0	1,5	0,6	32	92,6	104	13	3800	5000
	100	36	30,0	38,25	2,0	1,5	0,6	25	144	181	22	3800	5000
	100	36	30,0	38,25	2,0	1,5	0,6	31	131	174	21	3800	5000
50	80	20	15,5	20,00	1,0	1,0	0,3	18	59,6	87,4	11	4500	6000
	80	24	19	24	1	1	0,6	17	81	115	14	4300	6000
	85	26	20	26	1,5	1,5	0,6	20	92	110	13	4300	5600
	90	20	17,0	21,75	1,5	1,5	0,6	20	70,8	87,4	11	4200	5600
	90	23	19,0	24,75	1,5	1,5	0,6	21	81	102	12	4200	5600
	90	32	24,5	32	1,5	1,5	0,6	23	122	163	20	4000	5300
	110	27	23,0	29,25	2,5	2,0	0,6	23	121	141	17	3800	5000
	110	27	19,0	29,25	2,5	2,0	0,6	35	102	114	14	3300	4500
	110	40	33,0	42,25	2,5	2,0	0,6	27	174	224	27	3300	4500
	110	40	33,0	42,25	2,5	2,0	0,6	33	156	212	26	3200	4400

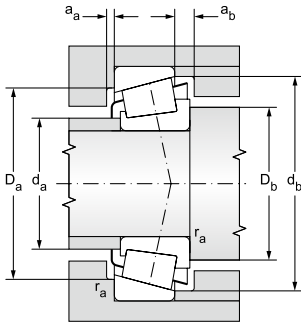

Bearing designation		Abutment and fillet dimensions									Weight	Factors		
ČSN	ISO	d	d _a	d _b	D _a	D _a	D _b	a _a	a _b	r _a	~	e	Y	Y ₀
			max	min	min	max	min	min	min	max				
mm											kg			
32008AX	T3CD040	40	45	46	60,0	62	65,0	4	4,5	1,0	0,29	0,38	1,60	0,9
33108	T2CE040		47	47	65	66	71	4	5,5	1	0,52	0,26	2,27	1,25
30208A	T3DB040		48	47	68,0	73	75,5	3	3,5	1,0	0,45	0,37	1,60	0,9
32208A	T3DC040		48	47	68,0	73	75,0	3	5,5	1,0	0,55	0,37	1,60	0,9
33208	T2DE040		47	47	67	71	76	5	7	1	0,74	0,36	1,68	0,92
30308A	T2FB040		50	49	76,0	81	82,0	3	5,0	1,5	0,77	0,35	1,70	1,0
30308AJ2	T2FB040		50	49	76,0	81	82,0	3	5,0	1,5	0,77	0,35	1,70	1,0
31308A	T7FB040		50	49	70,0	81	86,0	3	8,0	1,5	0,78	0,83	0,70	0,4
32308A	T2FD040		50	49	76,0	81	82,0	3	8,0	1,5	1,12	0,35	1,70	1,0
32308BA	T5FD040		50	49	70,0	81	85,0	4	8,0	1,5	1,11	0,54	1,10	0,6
32308BAJ2	T5FD040		50	49	70,0	81	85,0	4	8,0	1,5	0,99	0,54	1,10	0,6
32009AX	T3CC045	45	50	51	66,0	69	72,0	4	4,5	1,0	0,36	0,39	1,50	0,8
33009	T2CE045		52	52	67	69	78	5	7	0,5	0,43	0,29	2,04	1,12
33109	T3CE045		52	52	69	71	77	4	5,5	1	0,53	0,29	2,06	1,13
30209A	T3DB045		53	52	73,0	78	80,0	3	4,5	1,0	0,53	0,41	1,50	0,8
32209A	T3DC045		53	52	73,0	78	81,5	3	5,5	1,0	0,64	0,41	1,50	0,8
33209	T3DE045		52	52	72	76	81	5	7	1	0,79	0,39	1,56	0,86
30309A	T2FB045		56	54	85,0	91	92,0	3	5,0	1,5	1,04	0,35	1,70	1,0
30309AJ2	T2FB045		56	54	85,0	91	92,0	3	5,0	1,5	1,04	0,35	1,70	1,0
31309A	T7FB045		55	54	78,0	91	95,0	3	9,0	1,5	1,03	0,83	0,70	0,4
32309A	T2FD045		56	54	85,0	91	93,0	3	8,0	1,5	1,53	0,35	1,70	1,0
32309BAJ2	T5FD045		55	54	76,0	91	94,0	5	8,0	1,5	1,54	0,54	1,10	0,6
32010AX	T3CC050	50	55	56	71,0	74	77,0	4	4,5	1,0	0,4	0,42	1,40	0,8
33010	T2CE050		56	56	72	74	76	4	5	0,5	0,42	0,32	1,9	1,04
33110	T3CE050		56	57	74	76	82	4	6	1	0,6	0,32	1,88	1,04
30210A	T3DB050		58	57	78,0	83	86,5	3	4,5	1,0	0,6	0,42	1,40	0,8
32210A	T3DC050		58	57	78,0	83	85,0	3	5,5	1,0	0,67	0,42	1,40	0,8
33210	T3DE050		57	57	77	81	87	5	7,5	1	0,85	0,42	1,43	0,79
30310A	T2FB050		62	60	94,0	100	102,0	3	6,0	2,0	1,32	0,35	1,70	1,0
31310A	T7FB050		61	60	85,0	100	104,0	3	10,0	2,0	1,29	0,83	0,70	0,4
32310A	T2FD050		62	60	94,0	100	102,0	3	9,0	2,0	2,01	0,35	1,70	1,0
32310BA	T5FD050		62	60	83,0	100	103,0	5	9,0	2,0	1,99	0,54	1,10	0,6

Single row tapered roller bearings in metric dimensions

d = 55 to 70 mm

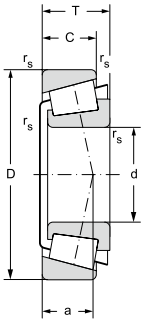

12.6.1

Main dimensions									Basic load rating		Fatigue load limit	Limiting speed for lubrication with	
d	D	B	C	T	r _{1s}	r _{2s}	r _{3s}	a	dynamic	static	P _u	grease	oil
					min	min	min		C _r	C _{or}			
mm									kN		kN	min ⁻¹	
55	90	23	17,5	23,00	1,5	1,5	0,6	20	76,4	108	13	4000	5300
	90	27	21	27	1,5	1,5	0,6	19	100	150	18	3800	5300
	95	30	23	30	1,5	1,5	0,6	22	114	160	20	3800	5000
	100	21	18,0	22,75	2,0	1,5	0,6	21	81	96,2	12	3800	5000
	100	25	21,0	26,75	2,0	1,5	0,6	22	102	128	16	3800	5000
	100	35	27	35	2	1,5	0,6	26	154	207	25	3600	5000
	120	29	25,0	31,50	2,5	2,0	0,6	25	136	162	20	3300	4500
	120	29	21,0	31,50	2,5	2,0	0,6	38	117	136	17	3000	4000
	120	43	35,0	45,50	2,5	2,0	0,6	29	200	256	31	3300	4500
60	95	23	17,5	23,00	1,5	1,5	0,6	21	81	119	15	3800	5000
	95	27	21	27	1,5	1,5	1	20	102	157	19	3600	5000
	100	30	23	30	1,5	1,5	1	23	110	174	21	3400	4800
	110	22	19,0	23,75	2,0	1,5	0,6	22	94,4	117	14	3300	4500
	110	28	24,0	29,75	2,0	1,5	0,6	25	126	162	20	3300	4500
	110	38	29	38	2	1,5	1	28	178	242	30	3400	4500
	130	31	26,0	33,50	3,0	2,5	1,0	26	162	188	23	3000	4000
	130	31	22,0	33,50	3,0	2,5	1,0	41	136	158	19	2800	3800
	130	46	37,0	48,50	3,0	2,5	1,0	31	228	299	36	2800	3800
	130	46	37,0	48,50	3,0	2,5	1,0	39	200	293	36	2500	3300
65	100	23	17,5	23,00	1,5	1,5	0,6	23	81	123	15	3300	4500
	100	27	21	27	1,5	1,5	1	21	103	163	20	3400	4500
	110	34	26,5	34,00	1,5	1,5	0,6	26	136	207	25	3800	5300
	120	23	20,0	24,75	2,0	1,5	0,6	24	112	136	17	3000	4000
	120	31	27,0	32,75	2,0	1,5	0,6	28	150	200	24	3000	4000
	120	41	32,0	41,00	2,0	1,5	0,6	30	191	267	33	3000	4000
	140	33	28,0	36,00	3,0	2,5	1,0	28	185	220	27	2800	3800
	140	33	23,0	36,00	3,0	2,5	1,0	44	150	178	22	2800	3800
	140	48	39,0	51,00	3,0	2,5	1,0	33	261	331	40	2800	3800
70	110	25	19,0	25,00	1,5	1,5	0,6	24	98,1	147	18	3300	4500
	110	31	25,5	31	1,5	1,5	1	22	140	225	28	3000	4300
	120	37	29	37	2	1,5	1	28	184	279	34	3000	4000
	125	24	21,0	26,25	2,0	1,5	0,6	26	121	153	19	3000	4000
	125	31	27,0	33,25	2,0	1,5	0,6	29	155	203	25	2800	3800
	125	41	32	41	2	1,5	1	31	224	312	38	2800	4000
	150	35	30,0	38,00	3,0	2,5	1,0	30	211	251	30	2700	3500
	150	35	25,0	38,00	3,0	2,5	1,0	47	178	211	25	2700	3500
	150	51	42,0	54,00	3,0	2,5	1,0	36	293	398	47	2700	3500

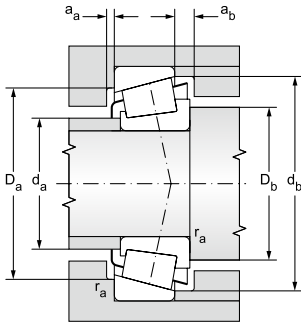

Bearing designation		Abutment and fillet dimensions									Weight	Factors		
ČSN	ISO	d	d _a	d _b	D _a	D _a	D _b	a _a	a _b	r _a	~	e	Y	Y ₀
			max	min	min	max	min	min	min	max				
mm											kg			
32011AX	T3CC055	55	61	62	80,0	83	86,0	4	5,5	1,0	0,59	0,41	1,50	0,8
33011	T2CE055		63	62	80	81	86	5	6	1	0,67	0,31	1,92	1,06
33111	T3CE055		63	62	83	86	91	5	7	1	0,89	0,29	2,06	1,13
30211A	T3DB055		63	64	87,0	91	94,0	4	4,5	1,5	0,76	0,41	1,50	0,8
32211A	T3DC055		63	64	87,0	91	95,0	4	5,5	1,5	0,92	0,41	1,50	0,8
33211	T3DE055		63	64	85	91	96	6	8	1,5	1,21	0,4	1,5	0,83
30311A	T2FB055		67	65	103,0	110	111,0	4	6,5	2,0	1,71	0,35	1,70	1,0
31311A	T7FB055		67	65	92,0	110	113,0	4	10,5	2,0	1,63	0,83	0,70	0,4
32311A	T2FD055		67	65	103,0	110	111,0	4	10,5	2,0	2,5	0,35	1,70	1,0
32012AX	T4CC060	60	66	67	85,0	88	91,0	4	5,5	1,0	0,63	0,43	1,40	0,8
33012	T2CE060		67	67	85	86	90	5	6	1	0,73	0,33	1,83	1,01
33112	T3CE060		67	67	88	91	96	5	7	1	0,89	0,4	1,51	0,83
30212A	T3EB060		69	69	95,0	101	105,5	4	4,5	1,5	0,97	0,41	1,50	0,8
32212A	T3EC060		69	69	95,0	101	104,0	4	5,5	1,5	1,27	0,41	1,50	0,8
33212	T3EE060		69	68	93	101	105	6	9	1,5	1,5	0,4	1,48	0,81
30312A	T2FB060		73	72	112,0	118	120,0	4	7,5	2,0	2,09	0,35	1,70	1,0
31312A	T7FB060		72	72	103,0	118	123,0	4	11,5	2,0	2,03	0,83	0,70	0,4
32312A	T2FD060		73	72	112,0	118	120,0	4	11,5	2,0	3,07	0,35	1,70	1,0
32312B	T5FD060		73	72	99,0	118	122,0	6	11,5	2,0	3,16	0,54	1,10	0,6
32013AX	T4CC065	65	71	72	90,0	93	97,0	4	5,5	1,0	0,68	0,46	1,30	0,7
33013	T2CE065		72	72	89	91	96	5	6	1	0,78	0,35	1,72	0,95
33113A	T3DE065		74	72	96,0	103	106,0	6	7,5	1,0	1,3	0,39	1,50	0,8
30213A	T3EB065		75	74	105,0	111	113,0	4	4,5	1,5	1,23	0,41	1,50	0,8
32213A	T3EC065		75	74	105,0	111	115,0	4	5,5	1,5	1,66	0,41	1,50	0,8
33213A	T3EE065		75	74	102,0	111	115,0	6	9,0	1,5	2,06	0,39	1,50	0,9
30313A	T2GB065		80	77	121,0	128	130,0	4	8,0	2,0	2,55	0,35	1,70	1,0
31313A	T7GB065		78	77	109,0	128	132,0	4	13,0	2,0	2,45	0,83	0,70	0,4
32313A	T2GD065		80	77	121,0	128	130,0	4	12,0	2,0	3,77	0,35	1,70	1,0
32014AX	T4CC070	70	77	77	98,0	103	105,0	5	6,0	1,5	0,89	0,44	1,40	0,8
33014	T2CE070		78	77	100	101	105	5	5,5	1	1,14	0,28	2,11	1,16
33114	T3DE070		80	79	104	111	115	6	8	1,5	1,75	0,38	1,58	0,87
30214A	T3EB070		80	79	108,0	116	118,0	4	5,0	1,5	1,37	0,42	1,40	0,8
32214A	T3EC070		80	79	108,0	116	119,0	4	6,0	1,5	1,73	0,42	1,40	0,8
33214	T3EE070		79	78	107	116	120	7	9	1,5	2,06	0,41	1,47	0,81
30314A	T2GB070		85	82	129,0	138	140,0	4	8,0	2,0	3,07	0,35	1,70	1,0
31314A	T7GB070		83	82	118,0	138	141,0	4	13,0	2,0	3,01	0,83	0,70	0,4
32314A	T2GD070		85	82	129,0	138	140,0	4	12,0	2,0	4,55	0,35	1,70	1,0

Single row tapered roller bearings in metric dimensions

d = 75 to 90 mm

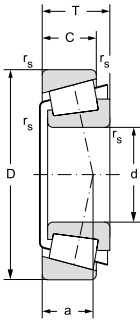

12.6.1

Main dimensions									Basic load rating		Fatigue load limit	Limiting speed for lubrication with	
d	D	B	C	T	r _{1s}	r _{2s}	r _{3s}	a	dynamic C _r	static C _{or}	P _u	grease	oil
mm									kN		kN	min ⁻¹	
75	115	25	19,0	25,00	1,5	1,5	0,6	25	104	158	19	3000	4000
	115	31	25,5	31	1,5	1,5	1	23	139	226	28	3000	4000
	125	37	29	37	2	1,5	1	30	189	293	36	2800	3800
	130	25	22,0	27,25	2,0	1,5	0,6	28	128	165	20	2800	3800
	130	31	27,0	33,25	2,0	1,5	0,6	30	162	220	27	2800	3800
	130	41	31,0	41,00	2,0	1,5	0,6	32	196	299	36	2800	3800
	160	37	31,0	40,00	3,0	2,5	1,0	32	242	287	33	2500	3300
	160	37	26	40	3	2,5	1	50	206	241	28	2200	3000
	160	55	45,0	58,00	3,0	2,5	1,0	38	341	464	54	2400	3200
	160	55	45,0	58,00	3,0	2,5	1,0	47	304	464	54	2000	2700
80	125	29	22,0	29,00	1,5	1,5	0,6	27	131	207	25	2800	3800
	125	36	29,5	36	1,5	1,5	1	26	189	315	38	2800	3600
	130	37	29,0	37,00	2,0	1,5	0,6	31	190	300	36	3200	4200
	140	26	22,0	28,25	2,5	2,0	0,6	29	144	178	21	2800	3800
	140	33	28,0	35,25	2,5	2,0	0,6	32	181	251	30	2800	3800
	140	46	35	46	2,5	2	1	35	256	394	47	2600	3400
	170	39	33	42,5	3	2,5	1	34	280	335	39	2200	3000
	170	39	27	42,5	3	2,5	1	53	224	268	31	2000	2800
	170	58	48	61,5	3	2,5	1	49	393	520	61	2200	3000
85	130	29	22,0	29,00	1,5	1,5	0,6	28	136	215	26	2800	3800
	130	36	29,5	36,00	1,5	1,5	0,6	26	195	319	38	3000	4000
	140	41	32	41	2,5	2	1	33	230	368	43	2400	3400
	150	28	24,0	30,50	2,5	2,0	0,6	30	181	207	24	2700	3500
	150	36	30,0	38,50	2,5	2,0	0,6	34	212,4	290,2	34	2400	3300
	150	36	30,0	38,50	2,5	2,0	0,6	34	237	293	34	2700	3500
	150	49	37,0	49,00	2,5	2,0	0,6	37	278	418	49	2200	3200
	180	41	34	44,5	4	3	1	36	309	373	41	2000	2800
	180	41	28	44,5	4	3	1	55	247	293	34	1900	2600
	180	60	49	63,5	4	3	1,5	51	413	570	65	2000	2800
90	140	32	24,0	32,00	2,0	1,5	0,6	30	150	228	27	2700	3500
	140	39	32,5	39,00	2,0	1,5	0,6	28	223	370	43	2800	3800
	150	45	35,0	45,00	2,5	2,0	0,6	36	265	420	48	2800	3800
	160	30	26,0	32,50	2,5	2,0	0,6	31	185	242	28	2400	3200
	160	40	34,0	42,50	2,5	2,0	0,6	37	251	355	40	2400	3200
	190	43	36	46,5	4	3	1,5	37	333	403	44	1900	2600
	190	43	30	46,5	4	3	1,5	58	270	320	36	1800	2400
	190	64	53,0	67,50	4,0	3,0	0,8	44	478	683	75	2000	2700

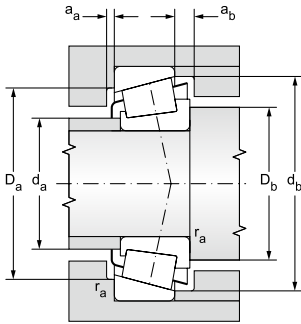

Bearing designation		Abutment and fillet dimensions									Weight	Factors		
ČSN	ISO	d	d _a	d _b	D _a	D _a	D _b	a _a	a _b	r _a	~	e	Y	Y ₀
			max	min	min	max	min	min	min	max	kg			
mm														
32015AX	T4CC075	75	82	82	103,0	108	110,0	5	6,0	1,0	0,96	0,46	1,30	0,7
33015	T2CE075		84	82	104	106	110	6	5,5	1	1,12	0,3	2,01	1,11
33115	T3DE075		84	84	109	115	120	6	8	1,5	1,74	0,4	1,51	0,83
30215A	T4DB075		85	84	113,0	121	124,0	4	5,0	1,5	1,47	0,44	1,40	0,8
32215A	T4DC075		85	84	113,0	121	121,0	4	6,0	1,5	1,82	0,44	1,40	0,8
33215A	T3EE075		85	84	111,0	121	125,0	6	10,0	1,5	2,3	0,43	1,40	0,8
30315A	T2GB075		91	87	138,0	148	149,0	4	9,0	2,0	3,72	0,35	1,70	1,0
31315	T7GB075		91	87	129	148	151	6	14	2,5	3,4	0,83	0,73	0,4
32315A	T2GD075		91	87	138,0	148	149,0	4	13,0	2,0	5,62	0,35	1,70	1,0
32315B	T5GD075		90	87	128,0	148	150,0	7	12,5	2,0	5,6	0,54	1,10	0,6
32016AX	T3CC080	80	87	87	112,0	118	120,0	6	7,0	1,0	1,32	0,42	1,40	0,8
33016	T2CE080		90	87	112	116	119	6	6,5	1	1,67	0,29	2,06	1,13
33116A	T3DE080		89	89	114,0	121	126,0	6	8,0	1,5	1,93	0,42	1,40	0,8
30216A	T3EB080		90	90	122,0	130	132,0	4	6,0	2,0	1,75	0,42	1,40	0,8
32216A	T3EC080		90	90	122,0	130	134,0	4	7,0	2,0	2,29	0,42	1,40	0,8
33216	T3EE080		89	90	122,0	130	135	7	11	2	3,01	0,41	1,45	0,8
30316	T2GB080		102	92	150	158	159	5	9,5	2,5	4,34	0,34	1,74	0,96
31316	T7GB080		97	92	136	158	159	6	15,5	2,5	4,2	0,83	0,73	0,4
32316	T5GD080		98	92	143	158	159	7	13,5	2,5	6,74	0,55	1,1	0,6
32017AX	T4CC085	85	92	92	117,0	123	125,0	6	7,0	1,0	1,41	0,44	1,40	0,7
33017A	T2CE085		92	93	117,0	123	125,0	6	6,5	1,0	1,73	0,29	2,10	1,1
33117	T3DE085		95	95	122	130	135	7	9	2	2,38	0,41	1,48	0,81
30217A	T3EB085		96	95	132,0	140	141,0	5	6,0	2,0	2,14	0,42	1,40	0,8
32217A	T3EC085		96	95	130,0	140	142,0	5	8,5	2,0	2,85	0,42	1,40	0,8
32217AJ2	T3EC085		96	95	130,0	140	142,0	5	8,5	2,0	2,85	0,42	1,40	0,8
33217A	T3EE085		96	95	128,0	140	144,0	7	12,0	2,0	3,69	0,42	1,40	0,8
30317	T2GB085		107	99	157	166	167	6	10,5	3,5	4,83	0,35	1,74	0,96
31317	T7GB085		103	99	144	166	169	6	16,5	3,5	4,9	0,83	0,73	0,4
32317	T5GD085		103	99	151	166	167	7	14,5	3,5	7,86	0,55	1,1	0,6
32018AX	T3CC090	90	99	99	124,0	131	134,0	6	8,0	1,5	1,78	0,42	1,40	0,8
33018A	T2CE090		99	99	124,0	131	135,0	6	6,5	1,5	2,25	0,27	2,20	1,2
33118A	T3DE090		101	100	130,0	140	144,0	7	10,0	2,0	3,2	0,40	1,50	0,8
30218A	T3FB090		102	100	138,0	150	150,0	5	6,0	2,0	2,71	0,42	1,40	0,8
32218A	T3FC090		102	100	138,0	150	152,0	5	8,5	2,0	3,6	0,42	1,40	0,8
30318	T2GB090		113	105	165	166	176	6	10,5	3,5	5,87	0,34	1,74	0,96
31318	T7GB090		109	105	152	176	179	6	16,5	3,5	5,4	0,83	0,73	0,4
32318A	T2GD090		109	104	157,0	176	177,0	7	14,5	2,5	8,81	0,35	1,70	0,9

Single row tapered roller bearings in metric dimensions

d = 95 to 120 mm

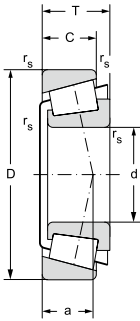

12.6.1

Main dimensions									Basic load rating		Fatigue load limit	Limiting speed for lubrication with	
d	D	B	C	T	r _{1s}	r _{2s}	r _{3s}	a	dynamic C _r	static C _{or}	P _u	grease	oil
mm									kN		kN	min ⁻¹	
95	145	32	24,0	32,00	2,0	1,5	0,6	31	174	280	32	2700	3500
	145	39	32,5	39,00	2,0	1,5	0,6	29	228	385	44	2700	3500
	170	32	27,0	34,50	3,0	2,5	1,0	33	214	272	30	2000	2900
	170	43	37,0	45,50	3,0	2,5	1,0	38	310	437	49	2700	3500
	200	45	38	49,5	4	3	1,5	40	350	420	45	1800	2500
	200	45	32	49,5	4	3	1,5	61	297	362	39	1700	2400
200	67	55	71,5	4	3	1,5	49	516	695	76	1900	2600	
100	150	32	24,0	32,00	2,0	1,5	0,6	33	178	261	30	2800	3800
	150	39	32,5	39,00	2,0	1,5	0,6	29	234	400	46	2500	3300
	180	34	29,0	37,00	3,0	2,5	1,0	37	266	346	38	2500	3300
	180	46	39,0	49,00	3,0	2,5	1,0	41	348	496	55	2500	3300
	215	47	39	51,5	4	3	1,5	42	411	500	58	1700	2400
	215	51	35	56,5	4	3	1,5	68	429	522	56	1500	2200
215	73	60	77,5	4	3	1,5	53	596	815	96	1700	2400	
105	160	35	26,0	35,00	2,5	2,0	0,6	35	205	337	38	2600	3400
	160	43	34,0	43,00	2,5	2,0	0,6	31	260	445	50	2400	3200
	190	36	30,0	39,00	3,0	2,5	1,0	37	293	387	42	2400	3200
	190	50	43,0	53,00	3,0	2,5	1,0	44	393	570	62	2400	3200
	225	77	63	81,5	4	3	1,5	56	638	878	100	1700	2200
110	170	38	29,0	38,00	2,5	2,0	0,6	37	246	390	43	2500	3300
	170	47	37,0	47,00	2,5	2,0	0,6	33	300	520	57	2200	3000
	200	38	32,0	41,00	3,0	2,5	1,0	39	304	402	43	1800	2500
	200	53	46,0	56,00	3,0	2,5	1,0	46	433	630	67	2200	3000
	240	50	42	54,5	4	3	1,5	45	474	583	67	1500	2000
	240	57	38	63	4	3	1,5	75	457	583	67	1400	1900
240	80	65	84,5	4	3	1,5	58	684	930	110	1500	2000	
120	180	38	29,0	38,00	2,5	2,0	0,6	40	254	430	46	2400	3200
	180	48	38	48	2,5	2	1,5	36	302	539	58	1800	2600
	215	40	34,0	43,50	3,0	2,5	1,0	43	339	452	47	1600	2200
	215	58	50,0	61,50	3,0	2,5	1,0	52	462	685	72	1600	2200
	260	55	46	59,5	4	3	1,5	48	566	710	78	1400	1900
	260	62	42	68	4	3	1,5	82	542	700	78	1300	1800
260	86	69	90,5	4	3	1,5	66	731	1045	110	1400	1900	

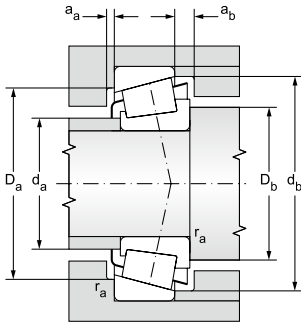

Bearing designation		Abutment and fillet dimensions									Weight	Factors		
ČSN	ISO	d	d _a	d _b	D _a	D _a	D _b	a _a	a _b	r _a	~	e	Y	Y ₀
			max	min	min	max	min	min	min	max				
mm											kg			
32019AX	T4CC095	95	105	104	130,0	136	139,0	6	8,0	1,5	1,87	0,44	1,40	0,8
33019A	T2CE095		103	104	130,0	136	139,0	6	6,5	1,5	2,34	0,28	2,10	1,2
30219A	T3FB095		107	110	148,0	158	159,0	5	7,0	2,0	3,16	0,42	1,40	0,8
32219A	T3FC095		107	110	148,0	158	161,0	5	10,0	2,0	4,32	0,42	1,40	0,8
30319	T2GB095		118	110	172	186	184	6	11,5	3,5	6,77	0,34	1,74	0,96
31319	T7GB095		114	110	158	186	187	6	17,5	3,5	6,7	0,83	0,73	0,4
32319	T2GD095		115	110	167	186	186	8	16,5	3,5	10,3	0,35	1,74	0,96
32020AX	T4CC100	100	109	109	134,0	141	144,0	6	8,0	1,5	1,94	0,46	1,30	0,7
33020A	T2CE100		109	110	134,0	141	144,0	6	6,5	1,5	2,47	0,28	2,10	1,1
30220A	T3FB100		114	112	155,0	168	168,0	5	8,0	2,0	3,81	0,42	1,40	0,8
32220A	T3FC100		114	112	155,0	168	171,0	5	10,0	2,0	5,21	0,42	1,40	0,8
30320	T2GB100		127	115	185	201	197	6	12,5	3,5	8,38	0,34	1,74	0,96
31320	T7GB100		121	115	169	201	202	7	21,5	3,5	8,8	0,83	0,73	0,4
32320	T2GD100		123	115	178	201	201	8	17,5	3,5	13,1	0,35	1,74	0,96
32021AX	T4DC105	105	116	115	143,0	150	154,0	6	9,0	2,0	2,51	0,44	1,40	0,7
33021A	T2DE105		116	116	143,0	150	153,0	6	9,0	2,0	3,06	0,28	2,10	1,2
30221A	T3FB105		120	117	163,0	178	178,0	8	9,0	2,0	4,94	0,42	1,40	0,8
32221A	T3FC105		120	117	163,0	178	178,0	6	10,0	2,0	6,38	0,42	1,40	0,8
32321	T2GD105		129	120	186	211	209	9	18,5	3,5	15,1	0,35	1,74	0,96
32022AX	T4DC110	110	120	120	152,0	160	163,0	6	9,0	2,0	3,09	0,43	1,40	0,8
33022A	T2DE110		121	121	150,0	159	160,0	6	10,0	2,0	3,87	0,29	2,10	1,2
30222A	T3FB110		125	122	171,0	188	187,0	8	9,0	2,0	5,32	0,44	1,40	0,8
32222A	T3FC110		125	122	171,0	188	190,0	6	10,0	2,0	7,56	0,44	1,40	0,8
30322	T2GB110		142	125	208	226	220	8	12,5	3,5	11,1	0,34	1,74	0,96
31322	T7GB110		135	125	191	226	224	7	25	3,5	12,3	0,83	0,73	0,4
32322	T2GD110		137	125	201	226	222	9	19,5	3,5	18,1	0,35	1,74	0,96
32024AX	T4DC120	120	130	130	162,0	170	173,0	6	9,0	2,0	3,32	0,46	1,30	0,7
33024	T2DE120		132	131	161	168	171	6	10	2	4,06	0,31	1,97	1,08
30224A	T4FB120		135	132	187,0	203	201,0	9	9,0	2,0	6,33	0,44	1,40	0,8
32224A	T4FD120		135	132	184,0	203	204,0	9	11,5	2,0	9,42	0,44	1,40	0,8
30324	T2GB120		153	135	223	246	237	7	13,5	3,5	14,3	0,34	1,74	0,96
31324	T7GB120		145	135	206	246	244	9	26	3,5	15,1	0,83	0,73	0,4
32324	T2GD120		148	135	216	246	239	9	21,5	3,5	21,1	0,35	1,74	0,96

Single row tapered roller bearings in metric dimensions

d = 130 to 200 mm

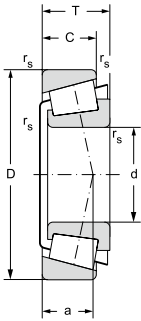

12.6.1

Main dimensions									Basic load rating		Fatigue load limit	Limiting speed for lubrication with	
d	D	B	C	T	r _{1s}	r _{2s}	r _{3s}	a	dynamic C _r	static C _{or}	P _u	grease	oil
mm									kN		kN	min ⁻¹	
130	200	45	34,0	45,00	2,5	2,0	0,6	43	330	560	59	2100	2800
	230	40	34	43,75	4	3	1,5	46	401	538	55	1500	2000
	230	64	54	67,75	4	3	1,5	56	555	845	96	1500	2000
	280	58	49	63,75	5	4	1,5	53	619	775	85	1300	1800
	280	66	44	72	5	4	1,5	87	611	788	87	1200	1700
	280	93	78	98,75	5	4	1,5	68	840	1130	130	1300	1800
140	210	45	34,0	45,00	2,5	2,0	0,6	46	335	580	60	1700	2200
	250	42	36	45,75	4	3	1,5	47	442	593	59	1400	1900
	250	68	58	71,75	4	3	1,5	60	647	1000	110	1400	1900
	300	62	53	67,75	5	4	1,5	52	664	845	90	1200	1700
	300	70	47	77	5	4	1,5	94	695	903	95	1100	1500
150	225	48	36	48	3	2,5	1,5	50	390	663	68	1400	2000
	270	45	38	49	4	3	1,5	52	492	665	65	1300	1800
	270	73	60	77	4	3	1,5	64	739	1150	130	1300	1800
	320	65	55	72	5	4	1,5	60	818	1045	110	1100	1500
	320	75	50	82	5	4	1,5	100	785	1033	110	1000	1460
	320	108	90	114	5	4	1,5	79	1330	1950	220	1100	1500
160	240	51	38	51	3	2,5	1,5	53	444	767	76	1300	1800
	290	48	40	52	4	3	1,5	51	558	760	73	1200	1600
	290	80	67	84	4	3	1,5	69	875	1395	150	1200	1600
	340	68	58	75	5	4	1,5	63	902	1160	120	1000	1400
170	260	57	43	57	3	2,5	1,5	57	548	956	93	1200	1700
	310	52	43	57	5	4	1,5	60	639	878	82	1100	1500
	310	86	71	91	5	4	1,5	74	1000	1610	170	1100	1500
180	280	64	48	64	3	2,5	1,5	60	679	1202	110	1200	1600
	320	52	43	57	5	4	1,5	62	660	928	86	1100	1400
	320	86	71	91	5	4	1,5	77	1015	1650	170	1100	1400
190	290	64	48	64	3	2,5	1,5	63	693	1231	120	1100	1500
	340	55	46	60	5	4	1,5	62	752	1043	95	1000	1300
	340	92	75	97	5	4	1,5	81	1150	1840	200	1000	1400
200	310	70	53	70	3	2,5	1,5	67	839	1449	140	1000	1400
	360	58	48	64	5	4	1,5	68	790	1090	98	900	1300
	360	98	82	104	5	4	1,5	83	1265	2035	200	950	1300

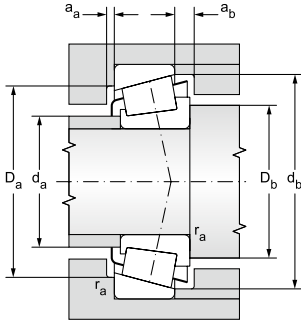

Bearing designation		Abutment and fillet dimensions									Weight	Factors		
ČSN	ISO	d	d _a	d _b	D _a	D _a	D _b	a _a	a _b	r _a	~	e	Y	Y ₀
			max	min	min	max	min	min	min	max				
mm											kg			
32026AX	T4EC130	130	140	140	178,0	190	192,0	8	11,0	2,0	5,05	0,44	1,40	0,8
30226	T4FB130		152	146	205	216	217	7	9,5	3,5	7,2	0,44	1,38	0,76
32226	T4FD130		146	146	196	216	219	7	13,5	3,5	11,7	0,44	1,38	0,76
30326	T2GB130		164	150	239	262	255	8	14,5	4,5	17,2	0,34	1,74	0,96
31326	T7GB130		157	150	220	262	261	8	28	4,5	19,2	0,83	0,73	0,4
32326			160	147	233	262	260	10	20,5	4,5	30,2	0,34	1,75	0,96
32028AX	T4DC140	140	150	150	186,0	200	202,0	8	11,0	2,0	5,26	0,46	1,30	0,7
30228	T4FB140		164	156	221	236	236	7	9,5	3,5	8,5	0,44	1,38	0,76
32228	T4FD140		159	156	213	236	238	8	13,5	3,5	14	0,44	1,38	0,76
30328	T2GB140		176	158	256	282	283	8	14,5	4,5	20,5	0,34	1,74	0,96
31328	T7GB140		169	160	236	282	280	9	30	4,5	35,5	0,8	0,75	0,41
32030-X	T4EC150	150	164	162	202	213	216	8	12	2,5	6,31	0,46	1,31	0,72
30230	T4GB150		175	116	236	256	256	9	11	3,5	11,1	0,44	1,38	0,76
32230	T4GD150		171	166	228	256	254	8	17	3,5	18,5	0,44	1,38	0,76
30330	T2GB150		189	168	275	302	292	9	17	4,5	25,5	0,34	1,74	0,96
31330	T7GB150		181	170	253	302	300	9	32	4,5	28,5	0,83	0,73	0,4
32330			184	167	264	302	299	12	24	4,5	45	0,24	2,53	1,39
32032-X	T4EC160	160	175	174	216	228	231	8	13	2,5	7,78	0,46	1,31	0,72
30232	T4GB160		189	176	253	276	269	8	12	3,5	13,2	0,44	1,38	0,79
32232	T4GD160		183	174	243	276	274	10	17	3,5	23,8	0,44	1,38	0,76
30332	T2GB160		201	180	293	322	310	9	17	4,5	29,9	0,35	1,74	0,96
32034-X	T4EC170	170	188	184	232	248	249	10	14	2,5	10,6	0,44	1,35	0,74
30234	T4GB170		203	190	273	292	288	8	14	4,5	17	0,44	1,38	0,76
32234	T4GD170		196	190	262	292	294	10	20	4,5	29,1	0,44	1,38	0,76
32036-X	T3FD180	180	199	194	248	268	267	10	16	2,5	14,2	0,42	1,42	0,78
30236	T4GB180		211	200	281	302	297	9	14	4,5	17,9	0,44	1,38	0,76
32236	T4GD180		204	200	270	302	303	10	20	4,5	29,9	0,45	1,33	0,73
32038-X	T4FD190	190	210	204	258	278	279	10	16	2,5	14,8	0,44	2,27	1,49
30238	T4GB190		224	210	302	322	318	9	14	4,5	21	0,44	1,38	0,76
32238	T4GD190		216	207	290	322	323	10	22	4,5	36,7	0,44	1,38	0,76
32040-X	T4FD200	200	222	214	277	298	297	11	17	2,5	18,9	0,43	1,39	0,77
30240A	T4GB200		237	218	315	342	336	9	16	3	25	0,43	1,40	0,8
32240	T3GD200		231	220	305	342	340	11	22	4,5	43,7	0,41	1,48	0,81

Single row tapered roller bearings in metric dimensions

d = 220 to 320 mm

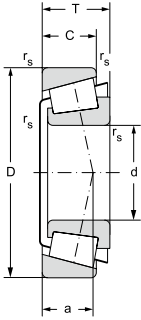

12.6.1

Main dimensions									Basic load rating		Fatigue load limit	Limiting speed for lubrication with	
d	D	B	C	T	r _{1s}	r _{2s}	r _{3s}	a	dynamic	static	P _u	grease	oil
					min	min	min		C _r	C _{or}			
mm									kN		kN	min ⁻¹	
220	340	76	57	76	4	3	1,5	73	963	1736	160	950	1300
	400	65	54	72	5	4	1,5	75	983	1367	120	850	1100
	400	108	90	114	5	4	1,5	94	1575	2625	250	850	1100
240	360	76	57	76	4	3	1,5	79	973	1804	160	850	1200
	440	120	100	127	5	4	1,5	105	1825	3250	300	750	1000
260	400	87	65	87	5	4	1,5	86	1191	2255	190	800	1100
	480	130	106	137	6	5	1,5	113	2220	3725	340	670	950
280	420	87	65	87	5	4	1,5	91	843	1782	150	710	1000
300	460	100	74	100	5	4	1,5	98	1604	3066	250	670	900
320	480	100	74	100	5	4	1,5	104	1615	3099	250	630	850

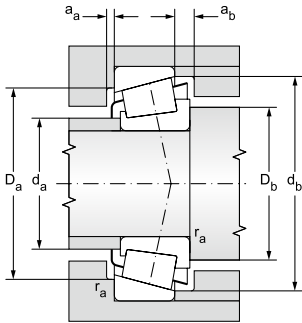

Bearing designation		Abutment and fillet dimensions									Weight	Factors		
ČSN	ISO	d	d _a	d _b	D _a	D _a	D _b	a _a	a _b	r _a	~	e	Y	Y ₀
			max	min	min	max	min	min	min	max				
mm											kg			
32044-X	T4FD220	220	244	236	303	326	326	12	19	3,5	24,4	0,43	1,39	0,77
30244	T4GB220		2559	242	350	382	371	10	18	4,5	34,6	0,42	1,43	0,79
32244			258	242	340	382	383	13	24	4,5	60,2	0,44	1,36	0,75
32048-X	T4FD240	240	262	256	321	346	346	12	19	3,5	25,1	0,46	1,31	0,72
32248			290	262	374	422	415	13	27	4,5	78,6	0,45	1,34	0,73
32052-X	T4FC260	260	287	282	357	382	383	13	22	4,5	38,1	0,43	1,38	0,76
32252			303	268	400	458	458	16	31	5,5	106	0,32	1,88	1,04
32056-X	T4FC280	280	305	302	384	402	402	14	22	4,5	66,3	0,46	1,31	0,72
32060-X	T4GD300	300	330	322	408	442	440	15	26	4,5	57,2	0,43	1,38	0,76
32064-X	T4GD320	320	350	342	430	462	460	15	26	4,5	59,4	0,46	1,31	0,72

Single row tapered roller bearings in inch dimensions d = 15.875 to 146.05 mm

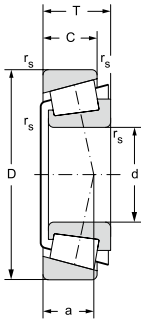

Main dimensions										Basic load rating		Fatigue load limit	Limiting speed for lubrication with		Bearing designation	
d	D	D ₁	B	C	C ₁	T	T ₁	r _{1s}	r _{2s}	s	dynamic	static	P _u	grease	oil	Cone/Cup
								min	min		C _r	C _{or}				
mm										kN		kN	min ⁻¹			
15,875	42,863		14,3	9,53		14,3		1,50	1,5	0,6	17,3	18,6	2,3	9500	14000	K-11590/ K-11520
16	47		21,0	16,00		21,0		1,00	2	5,9	36,9	40,6	5	8400	11000	K-HM81649/ K-HM81610
17,462	39,878		14,6	10,67		13,8		1,30	1,3	5,2	21,1	21,5	2,6	10000	13000	K-LM11749/ K-HM11710
19,05	45,237		16,6	12,07		15,5		1,30	1,3	5,5	25,6	26,6	3,2	8900	12000	K-LM11949/ K--LM11910
19,05	49,225		19,1	14,29		18,0		1,30	1,3	7,1	37,7	37,7	4,6	8900	12000	09067/ 09195
19,05	49,225		19,1	17,46		21,2		1,30	1,5	8,8	37,7	37,7	4,6	8900	12000	09067/ 09196
21,986	45,237		16,6	12,07		15,5		1,20	1,2	5,4	28,7	29,9	3,6	8400	11000	K-LM12749/ K-LM12710
22	45	51,5	16,6	12,07	3,0	15,5	6,4	1,20	1,2	5,4	28,7	29,9	3,6	8400	11000	L-LM12749/ K-LM12712B
25,4	50,292		14,7	10,67		14,2		1,30	1,3	3,3	24,6	28,7	3,5	7500	10000	K-L44643/ K--L44610
25,4	57,15		19,4	14,73		19,4		1,50	1,5	3	44,9	52,9	6,5	6400	8600	M84548/ 84510
25,4	59,93		23,1	18,29		23,4		0,80	1,57	5	44,7	66,8	8,1	5600	7500	K-M84249/ K-M84210
25,4	62		20,6	15,88		19,1		0,80	1,3	4,8	44,6	50,7	6,2	6400	8600	15101/ 15245
25,4	63,5		20,6	15,88		20,6		0,80	1,5	6,2	44,6	50,7	6,2	6400	8600	15101/ 15250X
26,988	50,292		14,7	10,67		14,2		3,56	1,3	3,3	24,6	28,7	3,5	7500	10000	K-L44649/ K-L44610
26,988	62		20,6	14,29		19,1		0,80	1,3	5,5	44,6	50,7	6,2	6400	8600	15106/ 15245
28,575	68,262		22,2	17,46		22,2		0,80	1,5	5,2	51	61,1	7,5	6000	8000	02474/ 0220
28,575	73,025		22,2	17,46		22,2		0,80	3,3	3,8	55	65,7	8	5500	7400	02872/ 02820
29	50,292		14,7	10,67		14,2		3,60	1,2	3,3	25,6	33,5	4,1	7100	9400	K-L45449/ K-L45410

d = 15.875 to 29 mm

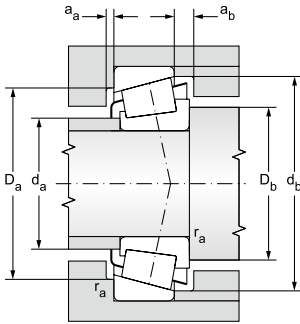

Abutment and fillet dimensions										Weight	Dimension deviations						Factors		
d _a	d _b	D _a	D _a	D _b	a _a	a _b	r _a	r _b		~	Δdmp		ΔDmp		ΔT _s		e	Y	Y ₀
max	min	min	max	min	min	min	max	max			max	min	max	min	max	min			
mm										kg	μm								
22,5	24,50	34,5	35	39,5	2,0	4,50	1,5	1,5		0,063	+13	0	+25	0	+200	0	0,7	0,9	0,5
23,0	22,00	36	39	43	2,0	4,00	1,0	1,5		0,20	0,00	-13	0	-25	+200	0	0,55	1,1	0,6
23,0	24,00	33,5	35	37	2,0	3,00	1,0	1,0		0,19	+13	0	+15	0	+200	0	0,29	2,1	1,1
25,0	25,50	38	38,5	41	3,0	3,00	1,0	1,0		0,12	+20	0	+25	0	+356	0	0,3	2	1,1
24,0	25,50	42	42,5	44,5	4,0	4,50	1,3	1,3		0,17	+13	0	+25	0	+203	0	0,27	2,26	1,2
24,0	25,50	41,5	42	44,5	1,0	4,50	1,3	1,5		0,19	+13	0	+25	0	+203	0	0,27	2,26	1,2
26,0	27,50	38	38,5	42,5	3,0	3,00	1,2	1,2		0,12	+13	0	0	+15	+200	0	0,31	1,96	1,1
26,0	27,50	-	-	46	1,2	3,50	1,3	-		0,13	-13,00	0	0	-15	+200	0	0,31	1,96	1,1
33,0	32,00	43,5	43,5	47	2,0	3,50	1,0	1,0		0,13	+13	0	+25	0	+200	0	0,37	1,6	0,9
33,0	36,00	48,5	49	54	2,5	5,00	1,5	1,5		0,23	+13	0	+25	0	+203	0	0,55	1,1	0,6
33,0	32,00	46	53	56	3,0	4,50	0,6	1,0		0,33	+13	0	+25	0	+200	0	0,55	1,1	0,6
31,5	32,50	55	56	58	5,0	5,00	0,8	1,3		0,29	+13	0	+25	0	+203	0	0,35	1,71	0,9
31,5	32,50	55	56	59	3,0	5,00	0,8	1,5		0,32	+13	0	+25	0	+203	0	0,35	1,71	0,9
33,0	38,00	43,5	45	47	3,0	3,50	3,0	1,0		0,12	+20	0	+25	0	+356	0	0,37	1,6	0,9
33,0	33,50	55	56	58	5,0	5,00	0,8	1,3		0,28	+13	0	+25	0	+203	0	0,35	1,71	0,9
36,0	36,50	59	60	63	3,0	5,50	0,8	1,5		0,40	+13	0	+25	0	+203	0	0,42	1,44	0,8
37,0	37,50	62	63	68	3,0	5,00	0,8	3,3		1,04	+13	0	+25	0	+203	0	0,45	1,32	0,7
34,0	40,00	43,5	45	47	3,0	3,50	3,0	1,0		0,11	+13	0	+15	0	+200	0	0,37	1,6	0,9

Single row tapered roller bearings in inch dimensions

d = 30 to 36.512 mm

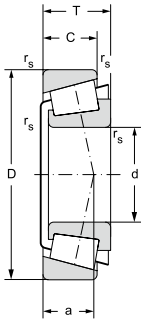

Main dimensions											Basic load rating		Fatigue load limit	Limiting speed for lubrication with		Bearing designation
d	D	D ₁	B	C	C ₁	T	T ₁	r _{1s}	r _{2s}	s	C _r	C _{or}	P _u	grease	oil	
mm											kN		kN	min ⁻¹		
30	62	68,5	18,1	15,54	3,6	17,3	5,3	1,00	1,5	2,8	44,7	44,7	5,5	6700	8900	K-JXC25640CB/ K-JXC25640D
30,162	64,292		21,4	16,67		21,4		1,57	1,57	2,9	44,7	59,6	7,3	5600	7500	K-M86649/ K--M86610
30,213	62		20,6	14,29		19,1		3,50	1,3	5,5	44,6	50,7	6,2	6400	8600	15118/ 15245
31,75	59,131		16,8	11,81		15,9		4,75	1,3	2,7	31,6	38,3	4,7	6700	8900	K-LM67048/ K-LM67010
31,75	62		19,1	14,29		18,2		4,75	1,3	4,6	47,3	58,4	7,1	6300	8400	K-15123/ K-15245
31,75	62		20,6	14,29		19,1		0,80	1,3	5,5	44,6	50,7	6,2	6400	8600	151126/ 15245
31,75	63,5		19,1	15,88		20,6		0,80	1,5	6,2	44,6	50,7	6,2	6400	8600	15123/ 15250X
31,75	69,012		19,6	15,88		19,8		3,50	3,3	4,1	46,1	55	6,7	5900	7800	14125A/ 14274
33,338	68,262		22,2	17,46		22,2		0,80	1,5	2,6	56,1	71,1	8,7	6000	7900	M88048/ 88010
34,925	65,088		18,3	13,97		18,0		4,75	1,3	3,7	43	53,1	6,5	5600	7500	K-LM48548/ K-LM48510
34,925	69,012		19,6	15,88		19,8		3,50	3,3	4,2	46,1	55	6,7	5900	7800	14138A/ 14274
34,925	72,233		25,4	19,84		25,4		2,30	2,3	4,1	66,9	87,4	11	5700	7600	HM88649/ 88610
34,925	73,025		24,6	19,05		23,8		1,50	2,3	8,1	72,2	87,3	11	5600	7400	25877/ 25820
34,925	76,2		28,6	23,81		29,4		1,50	3,3	8,9	80,9	97,4	12	5400	7200	31594/ 31520
34,988	61,973		17,0	13,60		16,7		0,80	1,5	1,8	39,4	52,4	6,4	5600	7500	LM78349/ 78310A
35	59,975		18,4	11,94		15,9		2,50	1,3	2,4	36	48,6	5,9	6400	8500	F15036/ JL68111Z
35	60		16,8	11,94		15,9		4,75	1,3	2,3	31,6	42,2	5,1	6300	8400	K-L68149/ K--L68111
36,487	76,2		25,7	19,05		23,8		1,50	3,3	7,6	81,1	105	13	5000	6700	2780/ 2720
36,512	76,2		28,6	23,02		29,4		3,50	3,3	6	79,5	107	13	5400	7200	HM89449/ 89410

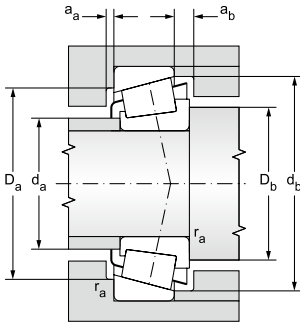

Abutment and fillet dimensions										Weight	Dimension deviations						Factors		
d _a	d _b	D _a	D _a	D _b	a _a	a _b	r _a	r _b		~	Δdmp		ΔDmp		ΔT _s		e	Y	Y ₀
max	min	min	max	min	min	min	max	max			max	min	max	min	max	min			
mm										kg	μm								
34,5	37,00	-	-	59	1,2	1,70	1,5	-	0,27	0,00	-12	+20	0	+200	0	0,37	1,6	0,9	
38,0	38,00	51	56,5	60	3,0	4,50	1,0	1,0	0,34	+13	0	+25	0	+200	0	0,55	1,1	0,6	
35,5	41,50	55	56	58	5,0	5,00	3,5	1,3	0,26	+13	0	+25	0	+203	0	0,35	1,71	0,9	
38,0	44,50	51	52	55	3,0	4,00	3,0	1,0	0,18	+13	0	+25	0	+356	0	0,41	1,5	0,8	
38,0	43,50	54	55	58	4,0	3,50	3,0	1,0	0,25	+13	0	+25	0	+203	0	0,35	1,7	0,9	
36,5	37,00	55	56	58	5,0	5,00	0,8	1,3	0,25	+13	0	+25	0	+203	0	0,35	1,71	0,9	
31,5	32,50	55	56	59	3,0	5,00	0,8	1,5	0,32	+13	0	+25	0	+203	0	0,35	1,71	0,9	
40,0	46,00	60	61	63	3,0	4,50	3,5	1,3	0,32	+13	0	+25	0	+203	0	0,38	1,57	0,9	
41,0	42,50	58	59	65	3,0	4,00	0,8	1,5	0,37	+13	0	+25	0	+203	0	0,55	1,1	0,6	
42,0	47,00	57	58	61	3,0	4,00	3,0	1,0	0,24	+20	0	+25	0	+356	0	0,38	1,6	0,9	
40,0	46,00	60	61,5	63	3,0	4,50	3,5	1,3	0,32	+13	0	+25	0	+203	0	0,38	1,57	0,9	
42,5	48,50	60	61,5	69	4,0	5,50	2,3	2,3	0,50	+13	0	+25	0	+203	0	0,55	1,1	0,6	
40,5	43,00	64	65,5	68	4,5	5,50	1,5	2,3	0,46	+13	0	+25	0	+203	0	0,29	2,07	1,1	
43,5	46,00	64	65,5	72	2,5	6,00	1,5	3,3	0,62	+13	0	+25	0	+203	0	0,4	1,49	0,8	
40,0	46,00	54	55,5	59	3,0	4,00		1,5	0,19	0,00	-13	0	-25	+203	0	0,44	1,35	0,8	
45,5	39,00	53	54,5	56	4,0	3,00	2,5	1,3	0,19	+13	0	+25	0	+203	0	0,42	1,44	0,8	
40,0	46,00	52	54	56	3,0	3,50	3,0	1,0	0,18	0,00	-20	0	-25	+356	0	0,42	1,4	0,8	
42,5	44,50	66	67,5	70	5,0	5,00	1,5	3,3	0,52	+13	0	+25	0	+203	0	0,3	1,98	1,1	
44,5	54,00	62	63,5	73	3,0	5,50	3,5	3,3	0,62	+13	0	+25	0	+203	0	0,55	1,1	0,6	

Single row tapered roller bearings in inch dimensions

d = 38 to 42.875 mm

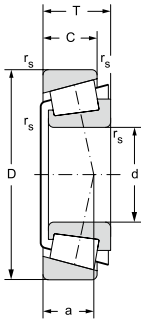

Main dimensions											Basic load rating		Fatigue load limit	Limiting speed for lubrication with		Bearing designation
d	D	D ₁	B	C	C ₁	T	T ₁	r _{1s}	r _{2s}	s	dynamic	static	P _u	grease	oil	Cone/Cup
								min	min		C _r	C _{or}				
mm											kN		kN	min ⁻¹		
38	63		17,0	13,50		17,0		1,50	1,5	2,4	42,2	55,2	6,7	6700	8900	K-JL69349/ K-JL69310
38,1	65,088		18,3	13,97		18,0		2,30	1,1	4,7	49,2	60,7	7,4	5600	7500	L-LM29749/ K-LM29710
38,1	65,088		18,3	15,75		19,8		2,30	1,3	5,6	42,9	56,5	6,9	5800	7800	LM29749/ 29711
38,1	69,012		19,1	15,08		19,1		3,50	2,3	3,3	49,2	62	7,6	5600	7500	13685/ 13621
38,1	76,2		25,7	19,05		23,8		3,50	3,3	7,6	81,1	105	13	5000	6700	2788/ 2720
38,1	82,55		28,6	23,02		29,4		0,80	3,3	4,9	87,3	117	14	4900	6600	HM801346/ 801310
38,1	88,5		29,1	22,23		27,0		3,50	1,5	9,1	98,2	112	14	4900	6500	418/ 414
39,688	80,167		30,4	23,81		29,4		0,80	3,2	11,3	81	104	13	4200	5600	K-3386/ K-3320
40	80		22,4	17,83		21,0		0,80	1,3	5,7	70,8	73,6	9	4700	6300	K-344A/ K-332
40,1	67,975		18,0	13,50		17,5		3,60	1,5	3,6	47,3	59,6	7,3	5300	7100	K-LM300849/ K--LM300811
40,988	67,975		18,0	13,50		17,5		0,80	1,5	3,6	46,1	63,5	7,7	5400	7200	LM300849/ 300811
41,275	73,025		17,5	12,70		16,7		3,50	1,5	2,5	45,9	55,8	6,8	5200	6900	18590/ 18520
41,275	73,431		19,8	14,73		19,6		3,50	0,8	3,4	57,8	73	8,9	5200	7000	LM501349/ 501310
41,275	73,431		19,8	16,60		21,4		3,50	0,8	4,5	57,8	73	8,9	5200	7000	LM501349/ 501314
41,275	76,2		23,0	17,46		22,2		3,50	0,8	4,7	66,3	83,3	10	5200	6900	24780/ 24720
41,275	87,312		30,9	23,81		30,2		1,50	3,3	10,5	95,8	120	15	4600	6200	3585/ 3525
41,275	88,9		29,4	23,02		30,2		3,50	3,3	4,5	99,6	125	15	4600	6100	HM803146/ 803110
42,875	82,931		25,4	19,05		23,8		3,50	0,8	6,2	77,2	100	12	4800	6300	25577/ 25520
42,875	82,931		25,4	22,23		27,0		3,50	2,3	8	77,2	100	12	4800	6300	25577/ 25523
42,875	83,058		25,4	19,05		23,8		3,50	3,3	6,2	77,2	100	12	4800	6300	25577/ 25521

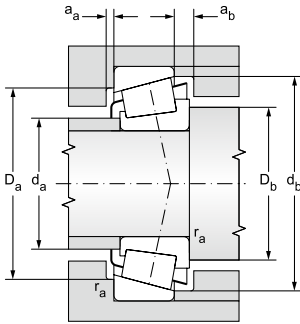

Abutment and fillet dimensions										Weight	Dimension deviations						Factors		
da	db	Da	Dd	Dd	da	db	ra	rb	~	Δdmp		ΔDmp		ΔTs		e	Y	Yo	
max	min	min	max	min	min	min	max	max		max	min	max	min	max	min				
mm										kg	μm								
41,0	49,00	56,5	57	60	1,5	3,50	1,5	1,5	0,20	+13	0	+25	0	+200	0	0,42	1,44	0,8	
42,5	46,00	58	60	62	4,0	4,00	2,3	1,3	0,24	+13	0	+25	0	+200	0	0,33	1,8	1,0	
42,5	46,00	58	59,5	62	1,5	4,50	2,3	1,3	0,24	+13	0	+25	0	+203	0	0,33	1,8	1,0	
43,0	49,50	61	62,5	65	2,5	4,00	3,5	2,3	0,28	+13	0	+25	0	+203	0	0,4	1,49	0,8	
43,5	50,00	66	67,5	70	5,0	5,00	3,5	3,3	0,49	+13	0	+25	0	+203	0	0,3	1,98	1,1	
49,1	51,00	68	69,5	78	3,0	6,00	0,8	3,3	0,76	+13	0	+25	0	+203	0	0,55	1,1	0,6	
44,5	51,00	77	78,5	80	5,0	6,00	3,5	1,5	0,82	+13	0	+25	0	+203	0	0,26	2,28	1,3	
48,0	47,00	68	70	75	3,0	4,00	0,6	3,0	0,70	+13	0	+25	0	+200	0	0,27	2,2	1,2	
48,0	47,00	68	73	75	3,0	4,00	0,6	1,0	0,51	+13	0	+25	0	+203	0	0,27	2,2	1,2	
45,0	52,00	58	61	63	4,0	4,00	0,6	1,5	0,23	+13	0	+25	0	+200	0	0,35	1,7	0,9	
45,0	52,00	61	62,5	65	3,5	5,00	**	1,5	0,23	0,00	-13	0	-25	+203	0	0,35	1,72	0,9	
46,0	53,00	66	67,5	69	4,0	5,50	3,5	1,5	0,27	+13	0	+25	0	+203	0	0,35	1,71	0,9	
46,5	53,00	67	68,5	70	3,5	5,50	3,5	0,8	0,32	+13	0	+25	0	+203	0	0,4	1,5	0,8	
46,5	53,00	66	67,5	70	1,5	5,50	3,5	0,8	0,34	+13	0	+25	0	+203	0	0,4	1,5	0,8	
47,0	54,00	68	69,5	72	3,5	5,50	3,5	0,8	0,41	+13	0	+25	0	+203	0	0,39	1,53	0,9	
48,0	50,00	75	76,5	81	3,5	6,50	1,5	3,3	0,82	+13	0	+25	0	+203	0	0,31	1,96	1,1	
53,0	60,00	74	75,5	85	4,0	7,50	3,5	3,3	0,89	+13	0	+25	0	+203	0	0,55	1,1	0,6	
49,0	55,00	74	75,5	77	4,5	5,50	3,5	0,8	0,58	+13	0	+25	0	+203	0	0,33	1,79	1,0	
51,0	58,00	72	73,5	77	1,0	5,50	3,5	2,3	0,58	+13	0	+25	0	+203	0	0,33	1,79	1,0	
51,0	58,00	72	73,5	77	1,0	5,50	3,5	2,3	0,58	+13	0	+25	0	+203	0	0,33	1,79	1,0	

Single row tapered roller bearings in inch dimensions

d = 44.45 to 50 mm

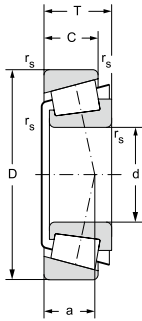

Main dimensions											Basic load rating		Fatigue load limit	Limiting speed for lubrication with		Bearing designation
d	D	D ₁	B	C	C ₁	T	T ₁	r _{1s}	r _{2s}	s	dynamic	static	P _u	grease	oil	Cone/Cup
								min	min		C _r	C _{or}				
mm											kN		kN	min ⁻¹		
44,45	83,058		25,4	19,05		23,8		3,56	3,2	6,2	59,6	87,4	11	4200	5600	K-25580/ K-25521
44,45	83,058		25,4	19,11		23,9		3,50	2	6,2	77,2	100	12	4800	6300	2580/ 25522
44,45	88,9		29,4	23,02		30,2		3,60	3,2	4,5	99,6	125	15	4600	6100	HM803149/ 803010
44,45	93,264		30,3	23,81		30,2		3,50	3,3	9	103	137	17	4200	5500	3782/ 3720
44,45	95,25		28,6	22,23		31,0		3,50	0,8	-0,7	99,7	120	15	3700	5100	HM903249/ 903210
44,45	104,775		36,5	28,58		36,5		3,50	3,3	7,5	141	195	24	3800	5100	HM807040/ 807010
45,23	79,985		20,6	15,08		19,8		2,00	1,3	3,3	62	78,5	9,6	4800	6400	17887/ 17831
45,242	73,431		19,8	15,75		19,6		3,50	0,8	4,9	55,6	78,1	9,5	5100	6700	LM102949/ 102910
45,242	77,788		19,8	15,08		19,8		3,60	0,8	2,2	57,1	73,5	9	4900	6500	LM603049/ 603011
45,242	77,788		19,8	15,80		19,8		1,00	1	1,9	59,6	77,9	9,5	4900	6500	LM603049/ LM603011
45,242	77,788		19,8	16,67		21,4		3,60	0,8	3,2	57,1	73,5	9	4900	6500	LM603049/ 603012
45,618	82,931		25,4	22,23		27,0		3,50	2,3	7,9	77,2	100	12	4800	6300	25590/ 25523
45,987	74,976		18,0	14,00		18,0		2,30	1,5	1,9	52,6	74,6	9,1	5000	6600	LM503349/ 503310
46,038	79,375		17,5	13,50		17,5		2,80	1,5	1,7	47,1	59,1	7,2	4800	6400	18690/ 18620
50	82		21,5	17,00		21,5		3,00	0,5	5,4	75,2	104	13	4500	6000	K-JLM104948/ K-JLM104910

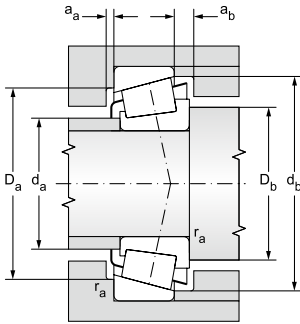

Abutment and fillet dimensions										Weight	Dimension deviations						Factors		
d_a	d_b	D_a	D_a	D_b	a_a	a_b	r_a	r_b	~		Δd_{mp}		ΔD_{mp}		ΔT_s		e	γ	γ_o
max	min	min	max	min	min	min	max	max		max	min	max	min	max	min				
mm										kg	μm								
53,0	56,50	71	74	73	5,0	4,50	3,0	3,0	0,54	+13	0	+25	0	+200	0	0,33	1,8	1,0	
50,0	57,00	73	74,5	77	4,5	5,50	3,5	2,0	0,56	+13	0	+25	0	+203	0	0,33	1,79	1,0	
53,4	62,00	74	75,5	85	7,5	4,00	3,6	3,2	0,84	+13	0	+25	0	+203	0	0,55	1,1	0,6	
52,0	58,00	82	83,5	88	3,5	7,00	3,5	3,3	0,95	+13	0	+25	0	+203	0	0,34	1,77	1,0	
54,0	65,00	81	82,5	91	2,0	7,00	3,5	0,8	1,00	+13	0	+25	0	+203	0	0,74	0,81	0,5	
59,0	66,00	89	90,5	100	4,0	7,00	3,5	3,3	1,62	+13	0	+25	0	+203	0	0,49	1,23	0,7	
51,0	56,00	71	72,5	74	3,5	5,00	2,0	1,3	0,40	+13	0	+25	0	+203	0	0,37	1,6	0,9	
50,0	56,00	68	69,5	70	3,0	4,50	3,5	0,8	0,31	+13	0	+25	0	+203	0	0,31	1,97	1,1	
50,0	57,00	71	72,5	74	5,0	3,50	3,6	0,8	0,36	+13	0	+25	0	+203	0	0,43	1,41	0,8	
50,0	57,00	71	72	74	4,5	5,50	1,0	1,0	0,38	+13	0	+25	0	+100	0	0,43	1,41	0,8	
50,0	57,00	71	72,5	74	5,0	2,00	3,6	0,8	0,37	+13	0	+25	0	+203	0	0,43	1,41	0,8	
51,0	58,00	72	73,5	77	1,0	5,50	3,5	2,3	0,58	+13	0	+25	0	+203	0	0,33	1,79	1,0	
51,0	55,00	67	68,5	71	3,5	5,00	2,3	1,5	0,30	0,00	-13	0	-25	+203	0	0,4	1,49	0,8	
51,0	56,00	71	72,5	74	3,5	5,00	2,8	1,5	0,33	+13	0	+25	0	+203	0	0,37	1,6	0,9	
55,0	60,00	76	77	78	4,0	4,50	3,0	0,5	0,41	-12,00	0	-18	0	+100	0	0,31	1,097	1,1	

Single row tapered roller bearings in inch dimensions

d = 50.8 to 65 mm

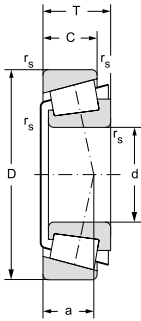

Main dimensions											Basic load rating		Fatigue load limit	Limiting speed for lubrication with		Bearing designation
d	D	D ₁	B	C	C ₁	T	T ₁	r _{1s}	r _{2s}	s	dynamic	static	P _u	grease	oil	Cone/Cup
								min	min		C _r	C _{or}				
mm											kN		kN	min ⁻¹		
50,8	82	22,2	17,00	22,0	22,0	3,50	0,5	5,9			61,2	84,3	10	4500	6000	LM104949/ 104910
50,8	82,55	22,2	16,51	21,6	21,6	3,50	1,3	5,7			61,2	84,3	10	4500	6000	LM104949/ 104911
50,8	85	17,5	13,50	17,5	17,5	3,50	1,5	0			49,7	65,5	8	4400	5900	18790/ 18720
50,8	88,9	22,2	16,51	20,6	20,6	3,50	1,3	3,8			74,3	87,3	11	4400	5800	368A/ 362A
50,8	90	22,2	15,88	20,0	20,0	3,50	2	3,3			74,3	87,3	11	4400	5800	368A/ 362X
50,8	92,075	25,4	19,85	24,6	24,6	3,50	0,8	4,3			84,8	119	15	4200	5600	28580/ 28521
50,8	93,264	30,3	23,81	30,2	30,2	3,50	3,3	9			103	137	17	4200	5500	3780/ 3720
50,8	101,6	36,1	29,99	34,9	34,9	0,80	3,2	11,8			123	162	20	3200	4200	K-529/ K-522
50,8	104,775	36,5	28,58	36,5	36,5	3,50	3,3	7,5			141	195	24	3800	5100	HM807046/ 807010
52,388	92,075	25,4	19,85	24,6	24,6	3,50	0,8	4,3			84,8	119	15	4200	5600	28584/ 28521
52,388	93,264	30,3	23,81	30,2	30,2	2,30	3,3	9			95,8	120	15	4600	6200	3767/ 3720
55	90	23,0	18,50	23,0	23,0	1,50	0,5	3			81,4	115	14	4200	5500	JLM506849/ 506810
57,15	96,838	21,9	15,88	21,0	21,0	2,30	0,8	2,6			80,4	101	12	3900	5200	387/ 382A
57,15	96,838	21,9	20,27	25,4	25,4	2,30	2,3	5,1			80,4	101	12	3900	5200	387/ 382S
57,15	98,425	21,9	17,83	21,0	21,0	2,40	0,8	1,6			80,4	101	12	3900	5200	387/ 382A
57,15	104,775	29,3	24,61	30,2	30,2	2,30	3,3	7,4			109	144	18	3700	4900	462/ 453X
57,15	127	44,5	34,93	44,5	44,5	3,50	3,3	9,2			228	276	34	3000	4000	K-65225/ K-65500
63,5	107,95	25,4	19,05	25,4	25,4	3,50	3,3	0,8			92,8	143	17	3400	4500	29585/ 29520
63,5	112,712	30,0	23,81	30,2	30,2	3,50	3,3	4,8			111	164	20	3400	4500	3982/ 3920
65	110	28,0	22,50	28,0	28,0	3,00	2,5	3,9			133	188	23	3300	4500	K-JM511946/ K-JM511910

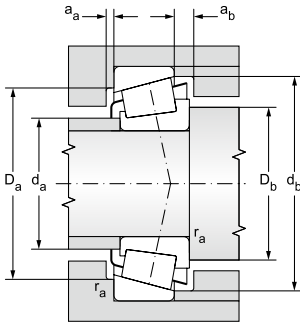

Abutment and fillet dimensions										Weight	Dimension deviations						Factors		
da	db	Da	Dd	Dd	da	db	ra	rb	ra	~	Δdmp		ΔDmp		ΔTs		e	Y	Yo
max	min	min	max	min	min	min	max	max			max	min	max	min	max	min			
mm										kg	μm								
55,0	62,00	76	77,5	78	5,5	4,50	3,5	0,5	0,42	+13	0	+25	0	+203	0	0,31	1,97	1,1	
55,0	62,00	75	76,5	78	4,5	5,50	3,5	1,3	0,42	+13	0	+25	0	+203	0	0,31	1,97	1,1	
56,0	62,00	77	78,5	80	3,5	5,00	3,5	1,5	0,36	+13	0	+25	0	+203	0	0,41	1,48	0,8	
56,0	62,00	81	82,5	84	5,0	5,50	3,5	1,3	0,50	+13	0	+25	0	+203	0	0,32	1,88	1,0	
56,0	62,00	81	82,5	84	5,0	5,50	3,5	2,0	0,51	+13	0	+25	0	+203	0	0,32	1,88	1,0	
57,0	63,00	83	84,5	87	3,5	5,00	3,5	0,8	0,69	+13	0	+25	0	+203	0	0,38	1,59	0,9	
58,0	64,00	82	83,5	88	3,5	7,00	3,5	3,3	0,84	+13	0	+25	0	+203	0	0,34	1,77	1,0	
61,0	63,50	87	89,5	94	6,0	7,50	0,6	3,0	1,22	+13	0	+25	0	+200	0	0,28	2,1	1,2	
63,0	70,00	89	90,5	100	4,0	7,00	3,5	3,3	1,49	+13	0	+25	0	+203	0	0,49	1,23	0,7	
58,0	65,00	83	84,5	87	3,5	5,00	3,5	0,8	0,66	+13	0	+25	0	+203	0	0,38	1,59	0,9	
59,0	63,00	82	83,5	88	3,5	7,00	2,3	3,3	0,81	+13	0	+25	0	+203	0	0,34	1,77	1,0	
61,0	63,00	82	83,5	86	3,5	5,00	1,5	0,5	0,55	0,00	-15	0	-18	+203	0	0,4	1,49	0,8	
62,0	66,00	89	90,5	92	5,5	6,00	2,3	0,8	0,58	+13	0	+25	0	+203	0	0,35	1,69	0,9	
62,0	69,00	87	88,5	91	5,5	6,00	3,5	2,3	0,64	+13	0	+25	0	+203	0	0,35	1,69	0,9	
62,0	66,00	89	90,5	92	6,0	5,00	2,4	0,8	0,61	+13	0	+25	0	+203	0	0,35	1,69	0,9	
63,0	67,00	92	93,5	98	3,0	5,50	2,3	3,3	1,04	+13	0	+25	0	+203	0	0,34	1,79	1,0	
71,0	80,00	104	107	119	10,0	10,00	3,5	3,3	2,79	+13	0	+25	0	+200	0	0,49	1,2	0,7	
71,0	77,00	96	97,5	103	3,0	6,00	3,5	3,3	0,91	+13	0	+25	0	+203	0	0,46	1,31	0,7	
71,0	77,00	99	100,5	106	3,5	6,50	3,5	3,3	1,22	+13	0	+25	0	+203	0	0,4	1,49	0,8	
71,0	77,00	93	96	101	9,5	9,50	3,0	2,5	1,05	-15,00	0	-15	0	+200	0	0,39	1,5	0,9	

Single row tapered roller bearings in inch dimensions

d = 66.675 to 89.974 mm

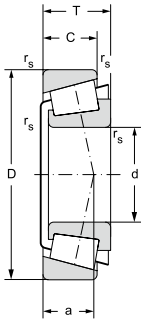

Main dimensions											Basic load rating		Fatigue load limit	Limiting speed for lubrication with		Bearing designation
d	D	D ₁	B	C	C ₁	T	T ₁	r _{1s}	r _{2s}	s	dynamic	static	P _u	grease	oil	Cone/Cup
								min	min		C _r	C _{or}				
mm											kN		kN	min ⁻¹		
66,675	110		22,0	18,82		22,0		0,80	1,3	-0,8	86,4	116	14	3400	4500	395A/ 394A
66,675	112,712		30,0	23,81		30,2		3,50	3,3	4,8	111	164	20	3400	4500	3984/ 3920
66,675	122,238		38,4	29,72		38,1		3,50	3,3	11,1	191	249	30	3200	4300	HM212049/ 212011
68,262	110		22,0	18,82		22,0		5,00	1,3	-0,8	86,4	116	14	3400	4500	399AS/ 394A
69,85	117,475		30,2	23,81		30,2		3,50	3,3	2,8	118	179	22	3200	4200	33275/ 33462
69,85	120		30,2	23,44		29,8		3,50	0,8	2,2	118	179	22	3200	4200	33275/ 33472
71,438	117,475		30,2	23,81		30,2		3,50	3,3	2,8	118	179	22	3200	4200	33281/ 33462
73,025	112,712		25,4	19,05		25,4		3,50	3,3	-0,9	97	155	19	3200	4300	29685/ 29620
73,025	117,475		30,2	23,81		30,2		3,50	3,3	2,8	118	179	22	3200	4200	33287/ 33462
80,962	150,089		46,7	36,51		44,5		5,00	3,3	11,7	264	368	43	2500	3400	740/ 742
82,55	125,412		25,4	19,85		25,4		3,50	1,5	-0,7	101	162	20	2900	3800	27687/ 27620
82,55	133,35		33,3	26,20		33,3		3,50	3,3	4,2	154	245	29	2700	3700	47686/ 47620
82,55	139,992		36,1	28,58		36,5		3,50	3,3	5,5	175	262	31	2700	3600	580/ 572
82,55	146,05		41,3	31,75		41,3		3,50	3,3	7,6	208	301	35	2600	3400	663/ 653
85,026	150,089		46,7	36,51		44,5		3,50	3,3	11,7	264	368	43	2500	3400	749/ 742
88,9	152,4		39,7	30,16		39,7		6,40	3,3	4,5	230	344	40	2000	3000	K-HM518445/ K-HM518410
89,974	146,975		40,0	32,50		40,0		7,00	3,5	9,3	243	365	42	2400	3300	L-HM218248/ K-HM218210

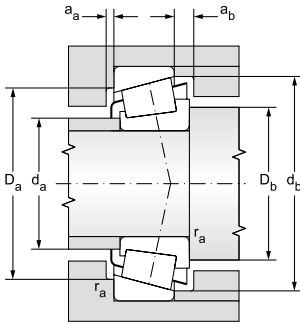

Abutment and fillet dimensions										Weight	Dimension deviations						Factors		
d _a	d _b	D _a	D _a	D _b	a _a	a _b	r _a	r _b	~	Δdmp		ΔDmp		ΔT _s		e	Y	Y ₀	
max	min	min	max	min	min	min	max	max		max	min	max	min	max	min				
mm										kg	μm								
73,0	73,00	101	102,5	104	4,5	4,00	0,8	1,3	1,06	+13	0	+25	0	+203	0	0,4	1,49	0,8	
74,0	80,00	99	100,5	106	3,5	6,50	3,5	3,3	0,78	+13	0	+25	0	+203	0	0,4	1,49	0,8	
82,0	75,00	108	109,5	116	9,0	6,50	3,5	3,3	1,84	+13	0	+25	0	+203	0	0,34	1,78	1,0	
74,0	83,00	101	102,5	104	4,5	4,00	5,0	1,3	0,72	+13	0	+25	0	+203	0	0,4	1,49	0,8	
77,0	84,00	104	105,5	112	3,5	6,50	3,5	3,3	1,25	+13	0	+25	0	+203	0	0,44	1,38	0,8	
77,0	84,00	104	105,5	112	3,5	6,50	3,5	3,3	1,25	+13	0	+25	0	+203	0	0,44	1,38	0,8	
79,0	85,00	104	105,5	112	3,5	6,50	3,5	3,3	1,18	+13	0	+25	0	+203	0	0,44	1,38	0,8	
80,0	86,00	101	102,5	109	3,5	6,00	3,5	3,3	0,88	+13	0	+25	0	+203	0	0,49	1,23	0,7	
80,0	87,00	104	105,5	112	3,5	6,50	3,5	3,3	1,17	+13	0	+25	0	+203	0	0,44	1,38	0,8	
91,0	101,00	134	135,5	142	7,0	9,50	5,0	3,3	3,39	+25	0	+25	0	+203	0	0,33	1,84	1,0	
89,0	96,00	115	116,5	120	4,0	6,50	3,5	1,5	1,04	+25	0	+25	0	+203	0	0,42	1,44	0,8	
90,0	97,00	119	120,5	128	5,0	7,50	3,5	3,3	1,69	+25	0	+25	0	+203	0	0,4	1,48	0,8	
91,0	98,00	125	126,5	133	4,0	7,00	3,5	3,3	2,14	+25	0	+25	0	+203	0	0,4	1,49	0,8	
92,0	99,00	131	132,5	139	5,0	8,00	3,5	3,3	2,75	+25	0	+25	0	+203	0	0,41	1,47	0,8	
95,0	101,00	134	135,5	142	7,0	9,50	3,5	3,3	3,21	+25	0	+25	0	+203	0	0,33	1,84	1,0	
98,0	112,00	124	135	142	6,0	10,00	3,5		2,88	+25	0	+25	0	+200	0	0,44	1,36	0,8	
99,0	112,00	128	133	141	6,0	7,50	3,5		2,59	+25	0	+25	0	+200	0	0,33	1,8	1,0	

Single row tapered roller bearings in inch dimensions

d = 90 to 146.05 mm

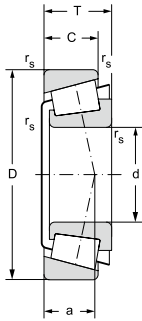

Main dimensions											Basic load rating		Fatigue load limit	Limiting speed for lubrication with		Bearing designation
d	D	D ₁	B	C	C ₁	T	T ₁	r _{1s}	r _{2s}	s	dynamic	static	P _u	grease	oil	Cone/Cup
								min	min		C _r	C _{or}				
mm											kN		kN	min ⁻¹		
90	145		34,0	27,00		35,0		6,00	2,5	2,2	213	315	37	2200	3200	K-JM718149/ K-JM718110
92,075	152,4		36,3	30,16		39,7		3,50	3,3	4,5	183	287	33	2400	3300	598/ 592A
146,05	193,675		28,6	23,02		28,6		5,80	1,5	-5,4	181	390	41	1700	2200	K-36691/

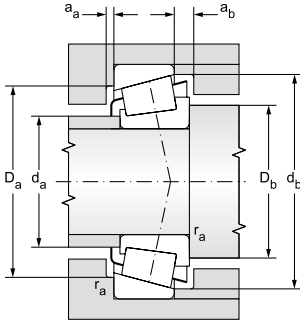

Abutment and fillet dimensions										Weight	Dimension deviations						Factors		
d_a	d_b	D_a	D_b	a_a	a_b	r_a	r_b				Δd_{mp}		ΔD_{mp}		ΔT_s		e	γ	γ_o
max	min	min	max	min	min	max	max			max	min	max	min	max	min				
mm										kg	μm								
99,0	111,00	126	131	140	6,0	8,00	2,5			2,15	+25	0	+25	0	+200	0	0,44	1,35	0,8
101,0	107,00	135	136,5	144	1,0	8,00	3,5	3,3		2,61	+25	0	+25	0	+203	0	0,44	1,36	0,8
155,0	162,00	176	182	187	6,0	6,50	1,5			2,31	+25	0	+25	0	+356	-254	0,37	1,6	0,9

Four-row tapered roller bearings d = 160 to 630 mm

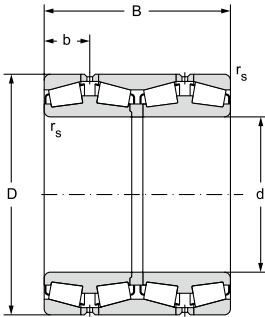

12.6.3

Main dimensions						Basic load rating		Fatigue load limit
d	D	B	r _{1s}	r _{2s}	b	dynamic	static	P _u
			min	min		C _r	C _{or}	
mm						kN		kN
160	240	145	2,5	2,5	34,25	799	1720	170
170	260	160	2,5	2,5	37,75	990	2140	210
180	280	180	2,5	2,5	42,50	1150	2490	240
190	290	180	2,5	2,5	42,50	1170	2600	240
200	310	200	2,5	2,5	47,50	1420	3110	290
220	340	218	3,0	3,0	51,75	1680	3770	340
240	360	218	3,0	3,0	51,75	1700	3920	340
260	400	250	4,0	4,0	59,75	2230	5080	430
280	420	250	4,0	4,0	59,75	2270	5290	440
300	460	290	4,0	4,0	69,25	2910	6760	550
320	480	290	4,0	4,0	69,25	2960	7040	570
340	520	325	5,0	5,0	77,50	3520	8530	670
360	480	218	3,0	3,0	51,75	2170	5990	480
	540	325	5,0	5,0	77,50	3580	8870	690
380	560	325	5,0	5,0	77,50	3650	9200	710
400	600	355	5,0	5,0	84,75	4340	10600	800
420	620	355	5,0	5,0	84,75	4420	11100	820
500	720	400	6,0	6,0	95,00	5390	14300	1 000
525	780	450	6,0	6,0	106,50	6660	17600	1 200
530	780	450	6,0	6,0	106,50	6660	17600	1 200
630	920	515	7,5	7,5	125,00	8730	24200	1 600



Limiting speed for lubrication with		Bearing designation	Weight	Factors			
grease	oil			e	Y1	Y2	Y0
min ⁻¹			kg				
710	940	36032	23,6	0,45	1,5	2,2	1,5
630	840	36034	30	0,46	1,5	2,2	1,5
590	780	36036	40,5	0,45	1,5	2,2	1,5
540	720	36038	42,5	0,47	1,4	2,2	1,4
500	670	36040	51,5	0,44	1,5	2,3	1,5
420	560	36044	71,6	0,45	1,5	2,3	1,5
400	530	36048	76,3	0,48	1,4	2,1	1,4
330	450	36052	111	0,44	1,5	2,3	1,5
320	420	36056	117	0,47	1,4	2,1	1,4
290	380	36060	169	0,44	1,5	2,3	1,5
260	340	36064	177	0,47	1,4	2,2	1,4
240	320	36068	241	0,44	1,5	2,3	1,5
240	320	36972	113	0,43	1,6	2,3	1,5
220	290	36072	253	0,46	1,5	2,2	1,4
200	260	36076**	263	0,48	1,4	2,1	1,4
190	250	36080**	339	0,44	1,5	2,3	1,5
180	240	36084**	351	0,46	1,5	2,2	1,4
140	190	360/500**	504	0,47	1,4	2,1	1,4
126	170	360/525**	713	0,45	1,5	2,2	1,5
120	160	360/530**	693	0,45	1,5	2,2	1,5
94	126	360/630**	1090	0,44	1,5	2,3	1,5